

SECTOR quick installation guide



CENTURION

SECTOR

CENTURION



SECTOR™



**HIGH-VOLUME
INDUSTRIAL
TRAFFIC
BARRIER**

Introduction >>

This quick guide is intended for the experienced installer who has done a SECTOR barrier installation before, knows all the safety aspects required of a site and only needs reminding of the basic steps to follow.



Always ensure that all the safety instructions described in the installation manual are adhered to during and after the installation process is completed.



If in doubt, refer to the installation manual, visit our website, www.centsys.co.za or call technical support on 0860-CENTURION

Icons used in this guide >>



This icon indicates tips and other information that could be useful during the installation.



This icon denotes variations and other aspects that should be considered during installation.



**This icon indicates warning, caution or attention!
Please take special note of critical aspects that **MUST** be adhered to in order to prevent injury.**

Required tools and equipment >>

Check that you have all the required tools to complete the installation.

Site considerations >>

Consider the following checklist when determining the safety and suitability of the site:

- Check that all safety and local authority requirements will be met
- Check that the usage (duty cycle) of the site and the length of the boom pole required, are within the barrier specifications
- Check that there is sufficient clearance on the side of the roadway to mount the barrier
- Check that a suitable foundation has been prepared for the barrier
- Check that the fitment of additional safety equipment has been catered for

Select operating mode >>

There are three Modes of Operation which can be selected, namely **Simplex**, **Complex** and **PLC**.

1. Simplex Mode

- Typical application would be the entrance to premises, which is controlled by a guard
- Raising and lowering of the boom pole is done via pushbutton or remote control connected to the memory input (MI). The **Autolower** feature can be used to automatically lower the boom pole after an adjustable **Autolower Time**

In **Simplex Mode**, the MI input will have the following characteristics:

- The input activates (the barrier responds) on the leading edge of the signal; in other words, the moment the button is pressed
- From the fully lowered position, pressing the button once will cause the boom pole to raise. A second button press will result in the boom reversing direction. In other words, the action is: press to raise, press to lower and, if the barrier is in a semi-raised position, press to reverse - NB - The barrier cannot be stopped in a midway position
- The NMI input operates exactly in the same way as MI when the SECTOR is in **Simplex Mode**, but the input activates on the trailing edge of the signal, i.e. when the button is released
- In **Simplex Mode** you can use standard infrared safety beams or a loop detector to prevent the barrier pole from being lowered onto a vehicle moving past the barrier. However, the closing loop is always recommended in preference to beams as it operates more reliably when used with barriers
- In this Mode of Operation, it will act purely as a safety loop and will not influence the closing of the barrier. However, the loop can be made to function as a closing loop if ILAC Mode is enabled
- ILAC Mode, which is comparable to PIRAC Mode as found on CENTURION gate motors, causes the boom to **Autolower** as soon as the inductive loop is cleared, i.e. the vehicle moves off. This is a desirable action in high-security applications and is an effective deterrent to tailgating

2. Complex Mode

- Typical application is any unmanned entrance, which makes use of any number of different access control devices to raise the boom pole
- In Complex Mode, the boom pole lowers the moment the vehicle has driven over and cleared the closing loop, which is mounted below the boom pole
- Access control devices, including proximity or card readers, keypads, remote controls, etc., are connected to the memory input (MI). The memory input counts and stores each trigger impulse. In this instance, more than in Simplex Mode, the MI input can be seen as a "memory input" since it counts and stores the pulses received and the barrier will only close once the corresponding number of activations and deactivations of the closing loop are received
- For example, say that someone presses the pushbutton three times to raise the boom, then it will be necessary for a vehicle to clear the closing loop three times before the boom will lower. If no closing signals are received, the boom will lower once the **Autolower Time** has expired. As with Simplex Mode described above, the input activates the moment that the button is pressed
- CENTURION recommends that the FLUX OB onboard inductive loop detector is used as the closing loop. Refer to page 9 for information on the FLUX OB onboard loop detector. This also acts as a safety loop while the vehicle is present on the loop detector. As an alternative, but not recommended is to use a set of infrared safety beams. It is recommended that two sets of safety beams are used, which are spaced about 500 millimeters apart
- There is a non-memory input (NMI) to raise the boom pole when activated by a ticket vending machine, pay parking system, etc. In **Complex Mode**, the boom will always lower the first time that a closing signal is received, irrespective of how many trigger impulses were received on the NMI input. For example, even if the button is pressed twice, the closing loop will only need to be cleared once for the pole to lower. As with **Simplex Mode**, the input is activated once the button is released

- A **Ticket Vend Interlock** output is available via a potential-free contact to prevent the issuing of tickets if the boom pole is raising or raised. These contacts can also be used as a potential-free contact for courtesy or security lights that illuminate automatically when the barrier is operated and remain illuminated for an adjustable period of time afterwards

2a. Free-exit (typically applicable to Complex Mode)

- It is possible to use the free-exit facility on the controller to automatically raise the barrier for vehicles exiting the parking area or premises
- It is recommended to use an **Inductive Loop Detector** to activate the free-exit facility. Alternatively, a set of infrared safety beams may be used, but this is not recommended
- The system can be configured for uni-directional traffic with the barrier dedicated as a free-exit barrier. The closing loop will be used to lower the barrier the moment the vehicle has exited
- It can also be configured for bi-directional traffic with the same barrier providing access control for vehicles entering and free-exit for vehicles exiting. The free-exit loop must be mounted close enough to the closing loop so that the vehicle exiting is still present on this loop when it reaches the closing loop. However, these must not be too close together, or magnetic interference will be caused

3. PLC mode

- In this Mode of Operation, separate inputs are controlled via pushbutton or directly from a third-party programmable logic controller or PC to raise, lower and stop the barrier
- There is one safety input for use with an **Inductive Loop Detector** or infrared safety beams to prevent the boom pole from lowering onto a vehicle



If mounting inductive loops in the ground, please refer to the manufacturer's instructions for full installation details.

4. Spike Mode

- This mode of operation will only be enabled if the controller is used as a CLAWS controller and will never be used on a standalone SECTOR
- The purpose of **Spike Mode** is simply to switch controller functionality to drive CLAWS

Cabling requirements >>

The cable requirements differ according to the mode that you have selected.



- All cables must be routed in conduit unless underground cable is being used
- For the detection of vehicles, CENTURION recommends installing Inductive Loop Detectors in preference to infrared beams

1. Simplex Mode

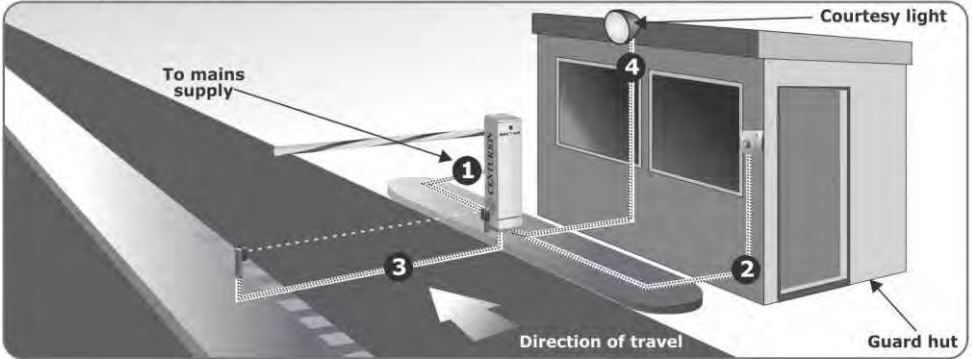

2. Complex Mode (basic)

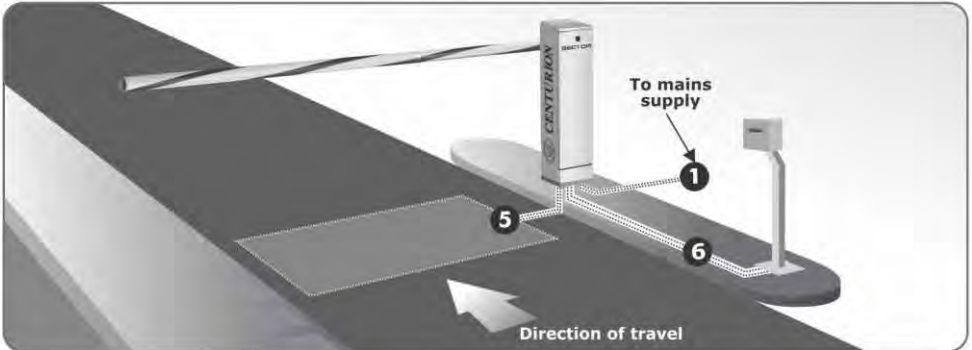

3a. Free-exit for uni-directional traffic

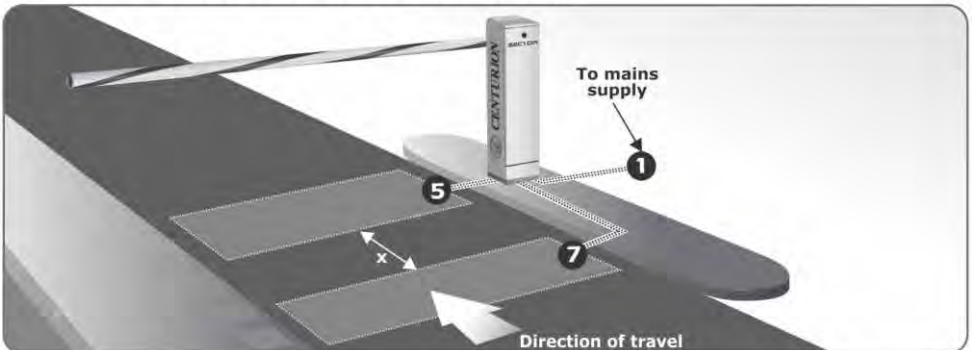

3b. Free-exit for bi-directional traffic

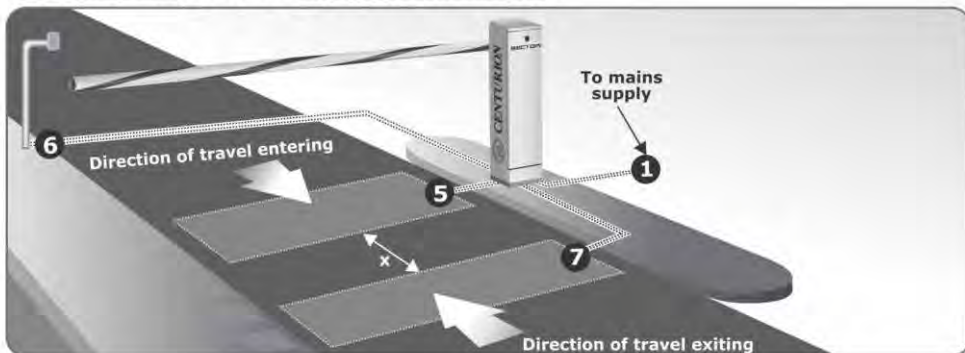

- **x refers to the distance required between the loops for free-exit**
- Free-exit for uni-directional traffic, x must be greater than 1000mm
- If FLUX OB is fitted, set the UNI-DIR FRX dipswitch to the ON position
- For bi-directional traffic, x must be less than the length of an average motor vehicle (between 1000mm and 2000mm). The exiting vehicle must not leave the free-exit loop before driving onto the closing loop. The barrier will raise when the exiting vehicle drives onto the free-exit loop. If FLUX OB is fitted, set the UNI-DIR FRX dipswitch to the OFF position

Legend

1. 220V AC mains cable (three core LNE 1.5mm² * SWA †)
2. Pushbutton control (two core 0.5mm² multi-stranded)
3. Infrared safety beams (three core 0.5mm² multi-stranded)
4. Optional pillar lights (three core LNE SWA † , size according to power requirements)
5. **Inductive loop Detector** for closing or safety (one core 0.5mm² multi-stranded silicone-coated)
6. Access control device (two core 0.5mm² multi-stranded †)
7. **Inductive Loop Detector** for free-exit (one core 0.5mm multi-stranded - silicone coated)
 - ★ Possibly increase cable thickness if pillar lights are installed
 - † Type of cable must adhere to municipal bylaws but typically SWA (steel wire armoured) cable is recommended. The armouring provides excellent screening, which gives better protection against lightning – earth one end of the screening
 - Consult manufacturer of loop detector for specific details, or refer to page 9 for information on the FLUX OB onboard inductive loop detector
 - ◇ Number of cores and type of cable could vary depending on brand of access control system being used

Orientation >>

- It is always recommended to mount the barrier with its access door facing the oncoming traffic. This ensures that if a vehicle accidentally hits the pole, the pole is knocked away from the barrier housing, not back onto the barrier housing, potentially damaging the housing



The default orientation is the operator on the right hand side of the roadway, with the pole pointing to the left - also referred to as right hand orientation

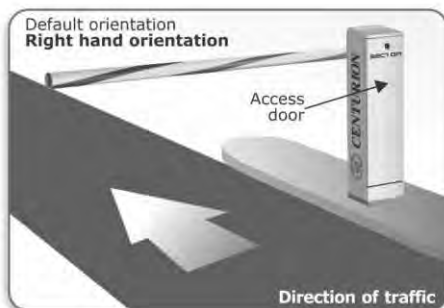



It is possible to change to **left hand orientation** allowing the barrier to be mounted on the left hand side of the roadway with the pole pointing to the right. Please contact CENTURION for details.

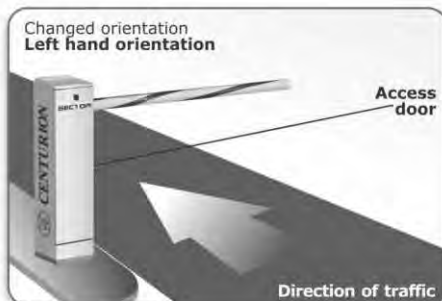

SECTOR installation >>

Enclosure positioning

- Determine correct position for the barrier to be installed



The dotted line denotes recommended dimensions of the concrete foundation

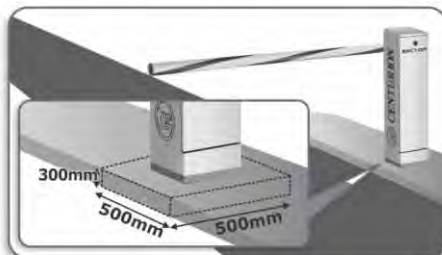

Check orientation of the door

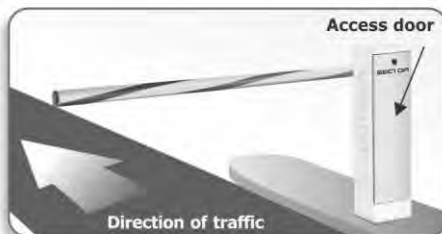

Concrete plinth/foundation

- Prepare hole for concrete foundation
- Install cable conduits, making sure that the conduits exit in cable entry area, leaving approximately 50mm of conduit protruding above the concrete plinth

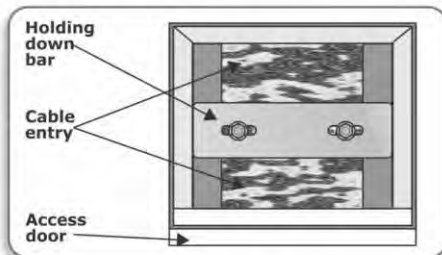

- Concrete in anchor bolts or fit shield anchor rawl bolts later (size M12 x 70)

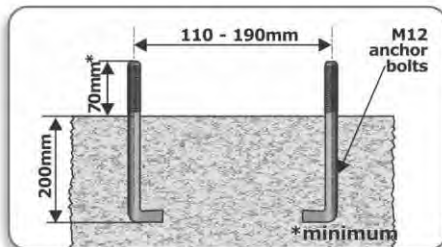



The enclosure is clamped down between the holding down bar and the concrete

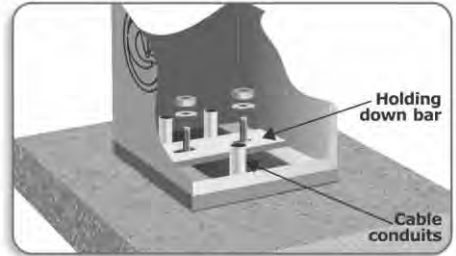

Fitting the boom pole

- Use the boom pole retainer piece as a ruler to mark a straight line on the boom pole

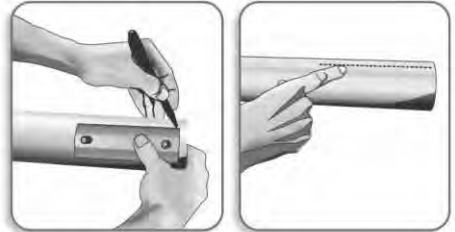

- Mark and drill the 8.5mm holes in the boom pole according to the measurements

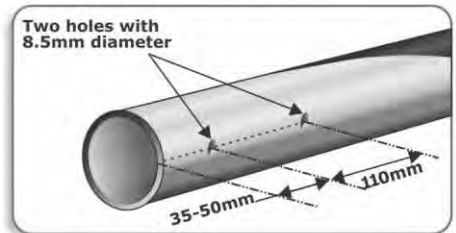

- Slide the boom pole retainer piece into the boom pole and push the mounting bolts through the drilled holes
- While holding the boom pole retainer piece in position, fit the boom pole onto the boom coupler
- Fit the M8 spring washers and nuts onto the bolts and tighten

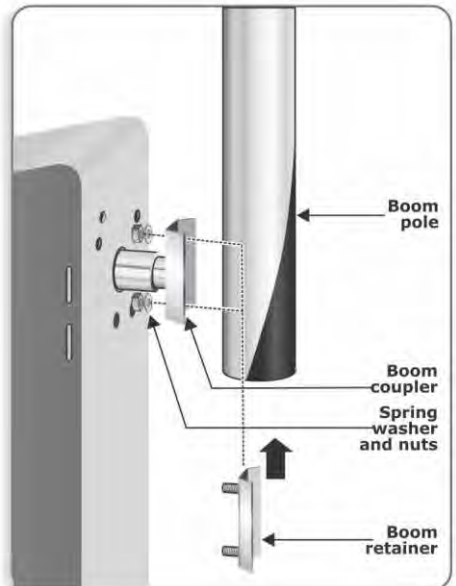

Leveling the boom pole

- Using a 17mm spanner, loosen the lock nuts on the adjustment link
- Turn the adjustment link to level the boom pole
- Tighten the lock nuts



Both of the lock nuts will loosen/tighten in the same direction. This might not be the expected direction - if the lock nut does not loosen/tighten try the other direction

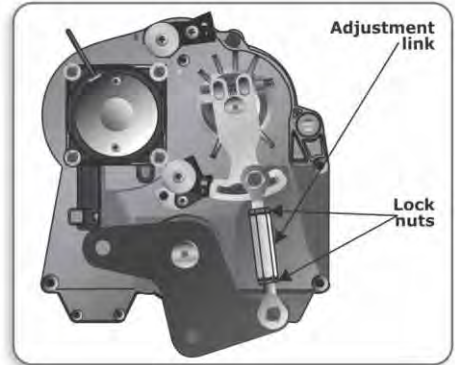

As the adjustment link is turned, the boom pole moves up or down. It is helpful to hold the adjustment link with a second spanner during this process



Locked at endstops

- By default the SECTOR does not lock at the endstops

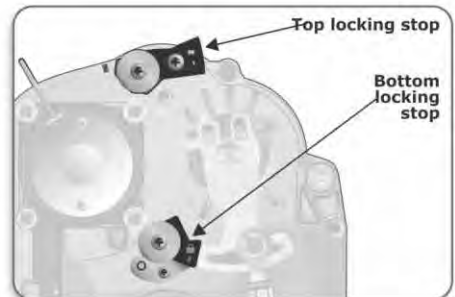

- In the event of a system failure the boom pole can be raised or lowered by hand



The barrier can be set to Lock Mode. Contact CENTURION for an explanation of Lock Mode and how to change between the configurations

Electrical setup >>

1. Always check that the circuit breaker in the electrical panel is in the OFF position, and that all high voltage circuits (more than 42.4V) are completely isolated from the mains supply before doing any work. The pole must be raised before isolating the system.
2. Ensure that all low voltage systems (less than 42.4V) are suitably protected from damage, by disconnecting all sources of power such as chargers and batteries before doing any work.
3. All electrical work must be carried out according to the requirements of all applicable local electrical codes. (It is recommended that a licensed electrical contractor perform such work).

Connect all wiring

1. Connect all cables as required for the specific installation.
2. Ensure all interconnecting cables are securely in place.
3. Ensure single phase mains power is connected to the system.
4. Switch on the mains (isolator and circuit breaker), make sure that the battery is connected and check that the polarity is correct.



The wiring diagrams on page 11 begin connection at the **termination board**, and **not** the controller

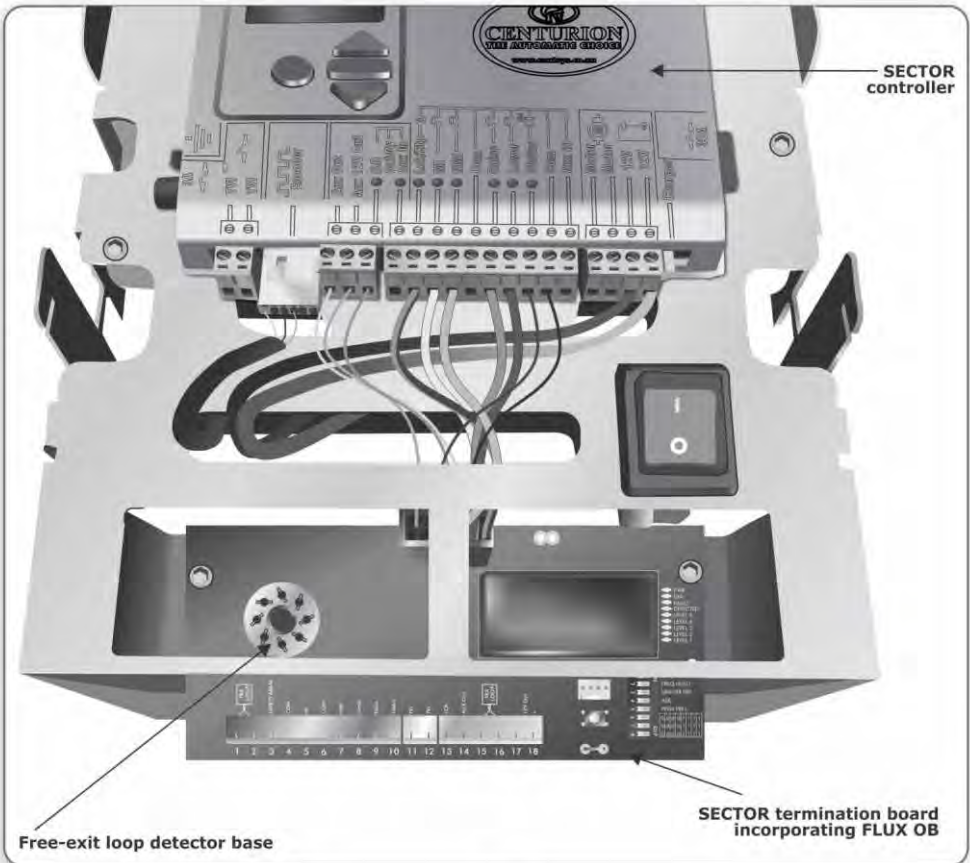

FLUX OB

- Some SECTOR traffic barrier models provide an onboard inductive vehicle loop detector known as the FLUX OB, which can be used for the connection of a closing loop, and is to be found on the SECTOR termination board.
- Setup of the FLUX OB is performed by means of a series of dipswitches and designated LEDs provide effective visual diagnostics.

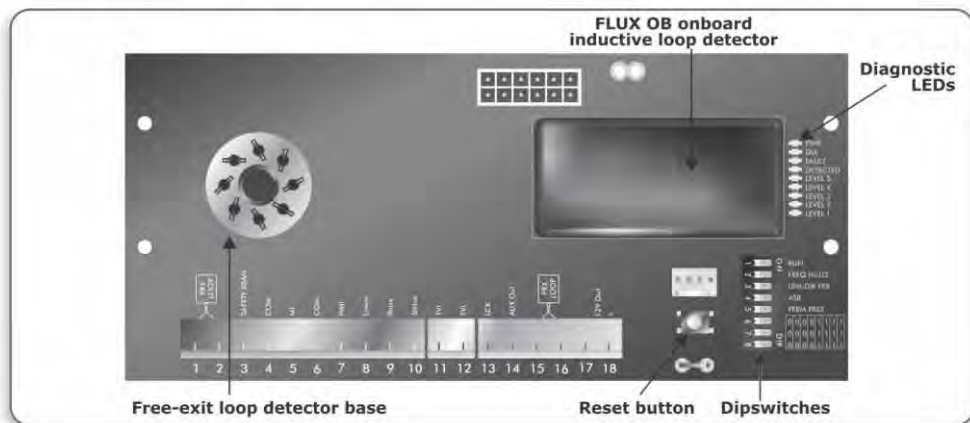

FLUX OB features

Reset button

- Pressing the reset button enables the detector to be manually reset at any time. This results in the detector retuning the sensing loop and becoming ready for vehicle detection. In addition, a 0.5S output pulse will be generated

Run switch

- If the switch is ON, the detector is in Run Mode, and functions normally. If OFF, the detector halts, and the output relay defaults to the detected state. This is useful when working on the SECTOR, as it will prevent the boom from lowering

Frequency selection switch

- The frequency of the loop is determined by the inductance of the loop and the frequency switch setting. If the frequency switch is ON, the frequency is reduced by approximately 25%. It may be necessary to change the frequency to prevent cross-talk between adjacent loops

Uni-directional Free-exit switch

- The switch is used to select between uni- and bi-directional traffic. If the switch is in the ON position, the loop detector will generate a "raise" pulse whenever a vehicle is detected on the Free-exit loop. If, however, the switch is in the OFF position, a raise pulse will only be generated if a detect signal is received from the Free-exit loop only, and never when a signal is received from the Free-exit loop and the closing loop simultaneously (bi-directional traffic)



It is very important that the distance between the free-exit loop and the closing loop is less than the length of one car

Automatic Sensitivity Boost (ASB) switch

- This option increases the sensitivity of the detector after initial detection of a vehicle. This is useful to reliably detect vehicle and trailer combinations. Sensitivity returns to the selected value once the vehicle has been undetected

Permanent presence switch

- If this switch is set to the ON position, detection will be maintained as long as a vehicle remains on the loop. The danger in using this setting is that any change in the environment (for example the introduction of metal into the vicinity of the loop) will not automatically be tuned out without pressing the reset button. If not selected, the loop will automatically tune out any permanent detection after five minutes

Adjustable loop sensitivity settings

- Eight sensitivity settings are available

Sensitivity	SENS1	SENS2	SENS3
High (0.03%)	ON	ON	ON
0.06%	ON	ON	OFF
0.1%	ON	OFF	ON
0.2%	ON	OFF	OFF
0.5%	OFF	ON	ON
1%	OFF	ON	OFF
2%	OFF	OFF	ON
Low (4%)	OFF	OFF	OFF

Commissioning the FLUX OB in a closing loop configuration

- With the loop connected, apply power to the SECTOR controller.
- The green Power LED on the termination board will light up, and the green Detect LED will flash until the loop has stabilised, and then turn off.
- Once the loop has stabilised, only the green power LED should be on.
- Bring a metal object towards the loop, and the Sense level LEDs will begin to light up, indicating the detection range of the loop.
- Once all five lights have lit up, the unit will enter detect, with the green detect LED lit.
- Configure the desired operational settings using the dipswitches.
- Test the FLUX OB using a metallic object, or a vehicle.

Separate loop detector module

- If your **SECTOR** vehicle traffic barrier has not been fitted with an onboard inductive loop detector, it is possible to install an external detector using one or both of the bases provided on the **SECTOR** termination board. Bases are provided for both Free-exit and closing loop connections.* Setup will be as per the individual detector. For more information on the different configurations and Modes of Operation as well as connecting closing and Free-exit loops, please refer to section 15, Electrical Setup

* 12V loop detectors MUST be used.

Simplex Mode: Option 1 (Recommended) - electrical connections

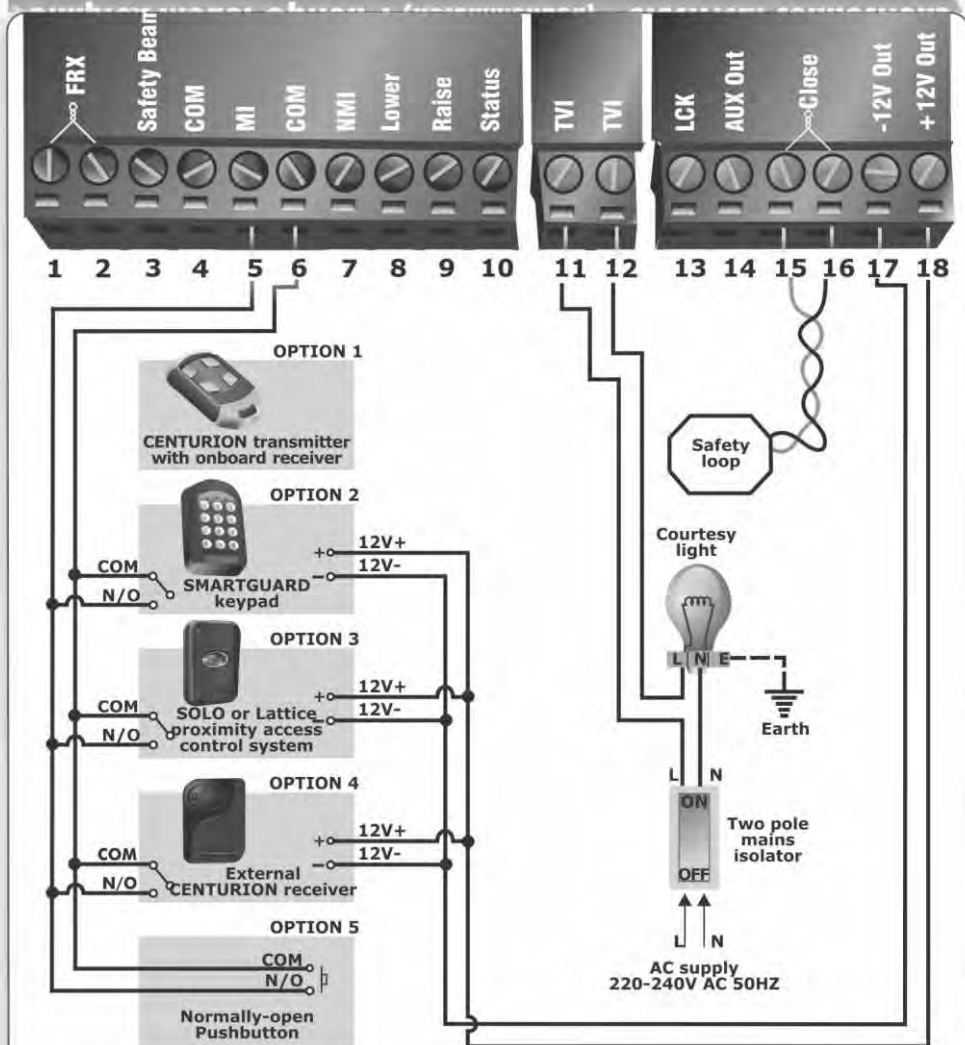

Option 1

All connections are made to the termination board and NOT the controller (Refer to page 8)

The different inputs to and outputs from the termination board, react according to the following when Simplex Mode is selected:

- **MI:** In this mode, the memory input acts simply to raise and lower the boom pole with sequential activations
- **Lower:** A dedicated input to only lower the boom pole
- **Raise:** A dedicated input to only raise the boom pole
- **TVI:** Potential-free contact that can be used for a courtesy or security light. The light illuminates when the barrier is operated and remains switched on for an adjustable period of time after the boom pole has lowered
- **Close (closing loop):** The FLUX OB onboard loop detector can be used or a closing loop detector must be fitted. In addition to sensing when the vehicle has passed the barrier for closing purposes, it will act as a safety loop preventing the boom pole from being lowered onto a vehicle present on the loop

Simplex Mode: Option 2 - electrical connections

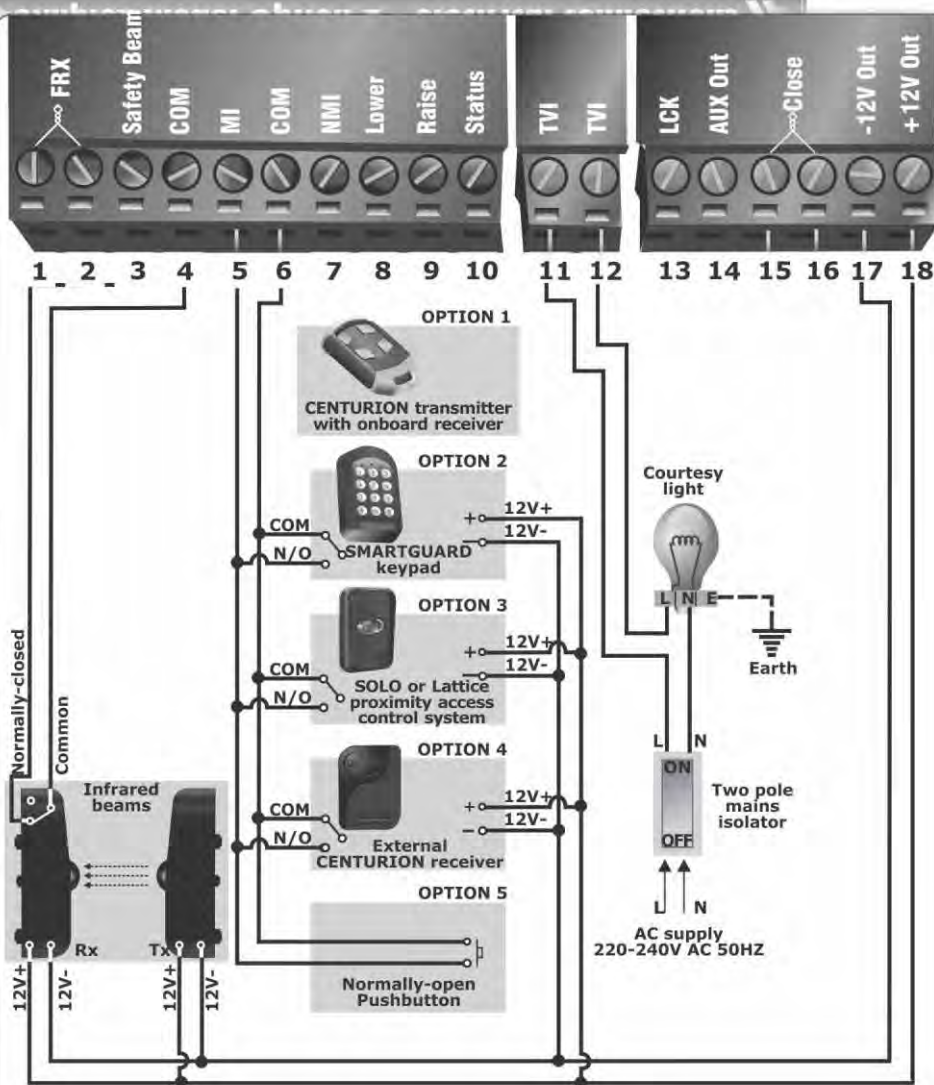

Option 2

All connections are made to the termination board and NOT the controller (Refer to page 8)

The different inputs to and outputs from the termination board, react according to the following when **Simplex Mode** is selected:

- **Safety Beam:** Infrared safety beams can be used as an alternative to an inductive loop, but not recommended
- **MI:** In this mode, the memory input acts simply to raise and lower the boom pole with sequential activations
- **Lower:** A dedicated input to only lower the boom pole
- **Raise:** A dedicated input to only raise the boom pole
- **TVI:** Potential-free contact that can be used for a courtesy or security light. The light illuminates when the barrier is operated and remains switched on for an adjustable period of time after the boom pole has lowered

Complex Mode: Option 1 (Basic) - electrical connections

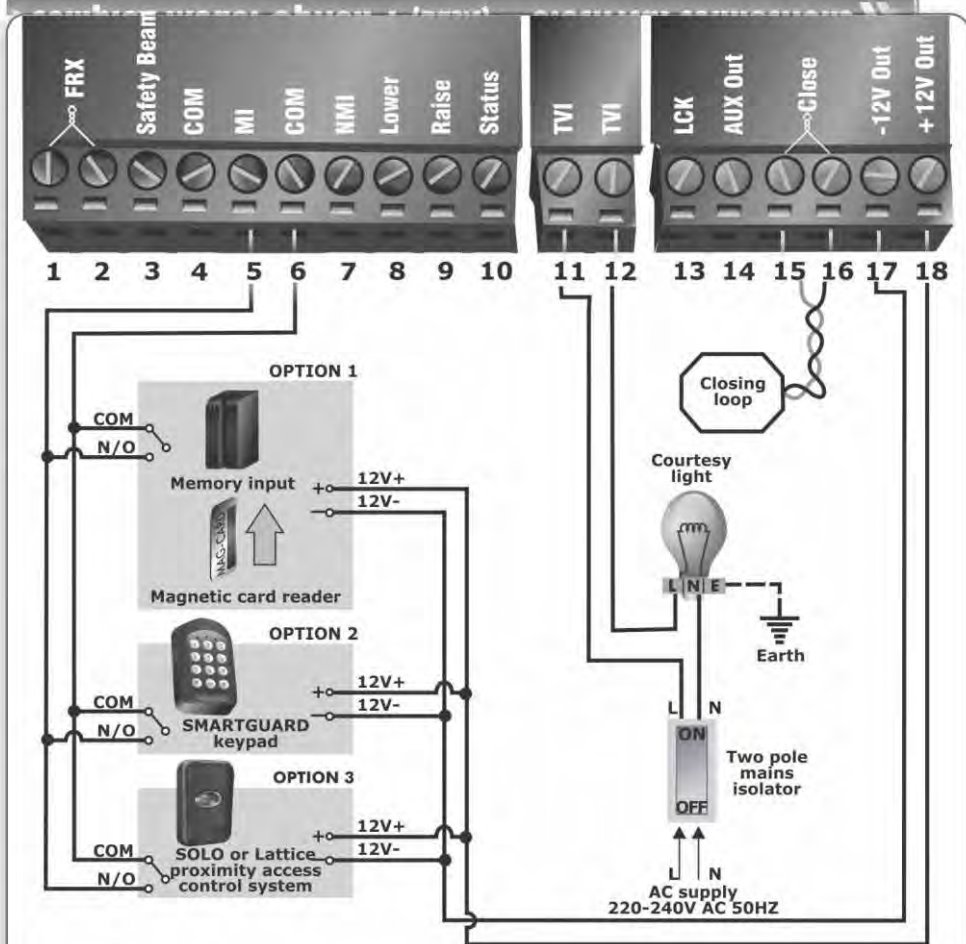

Option 1: Basic

All connections are made to the termination board and NOT the controller (Refer to page 8)

The different inputs to and outputs from the termination board, react according to the following when **Complex Mode** is selected:

- **Safety Beam:** Although not recommended, this input can be used if a closing loop detector is not fitted. It is recommended that two safety beams are used, which are spaced about 500 millimeters, horizontally apart
- **MI:** The memory input counts and stores each trigger impulse. The boom pole will stay raised until the same number of closing signals are applied to the closing input, or the Autolower time expires
- **NMI:** Typically used with ticket vending machines - refer to Option 2
- **Lower:** A dedicated input to only lower the boom pole
- **Raise:** A dedicated input to only raise the boom pole
- **TVI:** Potential-free contact that can be used for a courtesy or security light. The light illuminates when the barrier is operated and remains switched on for an adjustable period of time after the boom pole has lowered
- **Close (closing loop):** The FLUX OB onboard loop detector can be used or a closing loop detector must be fitted. In addition to sensing when the vehicle has passed the barrier for closing purposes, it will act as a safety loop preventing the boom pole from being lowered onto a vehicle present on the loop

Complex Mode: Option 2 (Ticket vend) - electrical connections

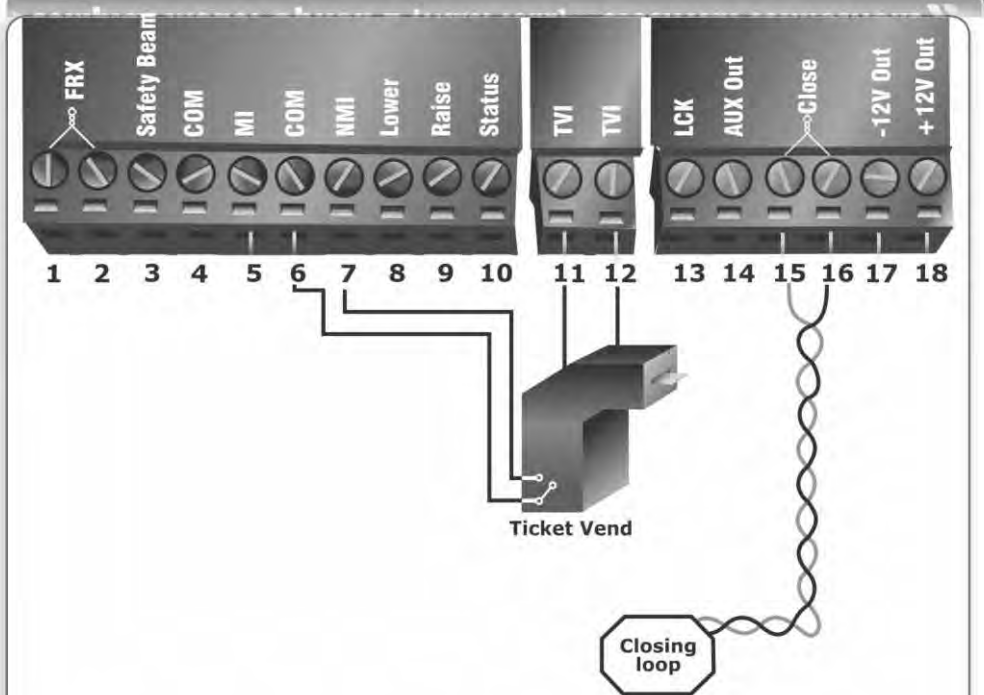

Option 2: Ticket vending entry points

All connections are made to the termination board and NOT the controller (Refer to page 8)

The different inputs to and outputs from the termination board, react according to the following when **Complex Mode** is selected:

- **Safety Beam:** Although not recommended, this input can be used if a closing loop detector is not fitted. It is recommended that two safety beams are used, which are spaced approximately 500 millimetres, horizontally apart
- **MI:** Typically not used
- **NMI:** Non-memory input responds only when the trigger signal to the input is removed. It does not react when the signal is given. Connect to the trigger output from the ticket vending machines
- **Lower:** A dedicated input to only lower the boom pole
- **Raise:** A dedicated input to only raise the boom pole
- **TVI:** Ticket Vend Interlock is a potential-free output that prevents the ticket vending machine from issuing another ticket until the boom pole is closing or is closed
- **Close (closing loop):** The FLUX OB onboard loop detector can be used or a closing loop detector must be fitted. In addition to sensing when the vehicle has passed the barrier for closing purposes, it will act as a safety loop preventing the boom pole from being lowered onto a vehicle present on the loop

Free-exit loop - electrical connections >>

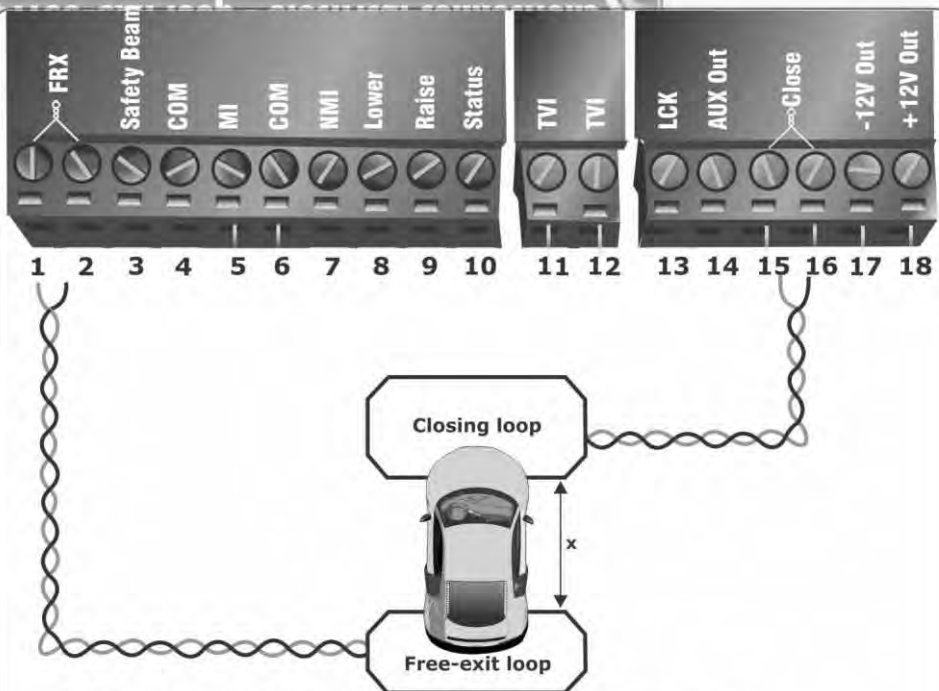

Option A: Free-exit single lane, unidirectional traffic (Refer to page 3)

All connections are made to the termination board and NOT the controller (Refer to page 8)

Please note the following:

- **FRX:** The free-exit loop detector must be fitted. The free-exit loop can be positioned any distance away from the closing loop, typically no less than 1000 millimeters, otherwise it may cause magnetic interference
 - Proceed to Menu level 6.3 and set the free-exit loop direction to UNI
- **Safety Beam:** Although not recommended, this input can be used if a closing loop detector is not fitted. It is recommended that two safety beams are used, which are spaced approximately 500 millimeters horizontally apart
- **Close (closing loop):** The FLUX OB onboard loop detector can be used or a closing loop detector must be fitted. In addition to raising the boom and sensing when the vehicle has passed the barrier for closing purposes, it will act as a safety loop preventing the boom pole from being lowered onto a vehicle present on the loop
- If FLUX OB is fitted, set the UNI-DIR FRX dipswitch to the ON position



Option B: Free-exit single lane, bi-directional traffic (Refer to page 4)

All connections are made to the termination board and NOT the controller (Refer to page 8)

Please note the following:

- **FRX:** The free-exit loop detector must be fitted. The free-exit loop must be mounted typically 1000 - 2000 millimeters from the closing loop. This is to ensure that the vehicle exiting is still present on this loop when it reaches the closing loop. It must not be any closer than 1000 millimeters, otherwise it may cause magnetic interference
 - Proceed to Menu level 6.3 and set the free-exit loop direction to BI
- **TVI:** Potential-free contact that can be used for a courtesy or security light. The light illuminates when the barrier is operated and remains switched on for an adjustable period of time after the boom pole has lowered
- **Close (closing loop):** The FLUX OB onboard loop detector can be used or a closing loop detector must be fitted. In addition to sensing when the vehicle has passed the barrier for closing purposes, it will act as a safety loop preventing the boom pole from being lowered onto a vehicle present on the loop
- If FLUX OB is fitted, the UNI-DIR FRX dipswitch must be set to OFF position

Setting up the limits and features for the SECTOR barrier >>

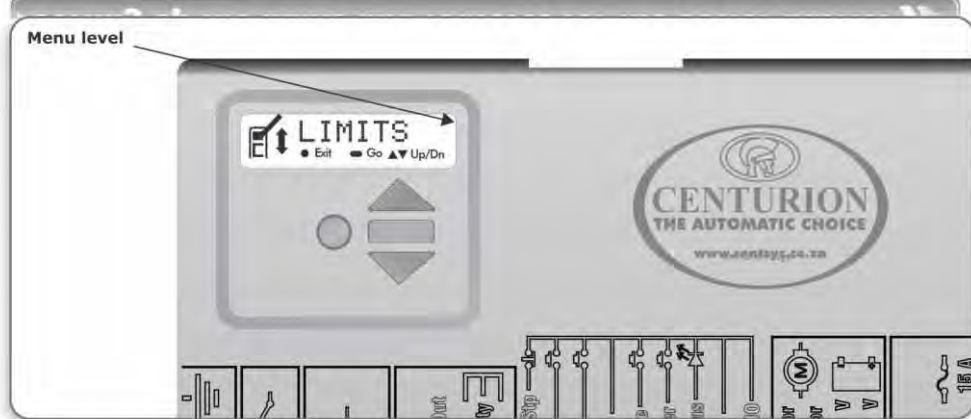

Setting up the limits

When setting up the SECTOR barrier system via the LCD display, all the steps that have to be followed are clearly provided via the display. It is only necessary to note the following:

- Press and hold the oblong enter (**■**) button for two seconds to enter **Setup Mode**
- If powering up for the first time (ex-factory), select the required profile that will suit the specific region (ZA - for South Africa, CE - for Europe and UL325 - for North America/Canada*)
- With this set, the system will automatically proceed to the limit setup menu. Follow the on-screen instructions to complete the setup procedure
- If powering up at any stage after this, press and hold the oblong enter (**■**) button for two seconds
- Select the **Limits Menu** by pressing the oblong enter (**■**) button. Follow the onscreen instructions to complete the setup procedure
- *The profile is compliant with UL325, but the barrier is not certified

Setting up additional features for the SECTOR barrier

The SECTOR navigation map that follows, provides the full menu of features that can be set up on the system.

A brief explanation of each feature is provided in the section, '**Controller features**'.

When setting up additional features, all the steps that have to be followed are clearly provided via the display.

It is only necessary to note the following:

- To get into **Setup Mode**, press the oblong **enter** (**■**) button for two seconds and follow the onscreen instructions
- The buttons provided on the controller for navigating the system, are not marked because at each step during the setup, the function given to each button is provided on the display
- When not in **Setup Mode**, ie **Normal Mode**, the round (**●**) button is used as a **test** button for operating the system. The up/down buttons are not used unless the diagnostic screens have been selected to appear in normal mode, in which case these buttons allow switching from one screen to the next
 - For each feature a **Factory Default** setting has been programmed into the controller. Referred to as an **Operating Standard or Profile**, these defaults have been determined to suit the requirements of the specific region where the installation is being carried out. It is only necessary to change a feature where the default does not suit the installation. When selecting any feature in the menu, details of the current setting stored in the controller are displayed
 - When selecting any of the features on a new or defaulted controller, the LCD will display the default value

SECTOR menu navigation map >>



1. Setting limits



1.1. Setup wizard



2. Safety

- 2.1. Collision force.....
 - 2.1.1. Raise collision force
 - 2.1.2. Lower collision force
- 2.2. Collision count
- 2.3. Alarm output
- 2.4. LCK input as ESTOP
- 2.5. External boom status indication.....
 - 2.5.1. Indicator output
 - 2.5.2. Lowered indication
 - 2.5.3. Partly lowered indication
 - 2.5.4. Lowering indication
 - 2.5.5. Partly raised indication
 - 2.5.6. Raising indication
 - 2.5.7. Raised Indication
 - 2.5.8. Unknown indication



3. Autolower

- 3.1. Autolower status
- 3.2. Autolower timer
- 3.3. Autolower override
- 3.4. Autolower advanced.....
 - 3.4.1. Autolower fully raised
 - 3.4.2. Autolower partly raised
 - 3.4.3. Autolower partly lowered



4. Modes of Operation

- 4.1. Operating mode



5. Run profile

- 5.1. Lock boom at endpoints.....
 - 5.1.1. Lock when raised
 - 5.1.2. Lock when lowered
 - 5.1.3. Holding force
- 5.2. Raise when mains fail
- 5.3. Spike interface
- 5.4. Pre-raising delay
- 5.5. Pre-lowering delay
- 5.6. Raising speed
- 5.7. Lowering speed
- 5.8. Ramp-up distance
- 5.9. Ramp-down distance
- 5.10. TRG stop distance
- 5.11. Loop stop distance
- 5.12. Crawl distance
- 5.13. Torque limit



6. Loop detector

- 6.1. ILAC control
- 6.2. Rollback time
- 6.3. FRX loop direction
- 6.4. Inductive loop alarms.....
 - 6.4.1. Presence alarm.....
 - 6.4.1.1. Presence alarm status
 - 6.4.1.2. Presence time
 - 6.4.2. Break-in alarm
 - 6.4.3. Alarm output



7. TVI output

- 7.1. TVI output function
- 7.2. TVI output polarity
- 7.3. Light timer



8. ChronoGuard

- 8.1. Time and date
- 8.2. Time-periods.....
 - 8.2.1. Add Time-period.....
 - 8.2.1.1. Auto-function
 - 8.2.1.2. Time-bar function
 - 8.2.2. Delete Time-period
 - 8.2.3. Edit/review Time-period
- 8.3. Exclusions.....
 - 8.3.1. Add exclusion.....
 - 8.3.1.1. Auto-function
 - 8.3.1.2. Time-bar function
 - 8.3.2. Delete exclusion
 - 8.3.3. Edit review exclusion
- 8.4. Delete all Time-periods and exclusions



9. General settings

- 9.1. Operating standard
- 9.2. Reset options.....
 - 9.2.1. Factory defaults
 - 9.2.2. Delete all remotes
 - 9.2.3. Delete all time periods and exclusions
 - 9.2.4. Reset all
- 9.3. Diagnostic screen status
- 9.4. Round test button status
- 9.5. Backup EEPROM
- 9.6. Restore EEPROM



10. Remote controls

 Press button of valid transmitter *(if menu locked)*

- 10.1. Add remotes
- 10.2. Delete remotes.....
 - 10.2.1. Delete by ID
 - 10.2.2. Delete button
 - 10.2.3. Delete by button
 - 10.2.4. Delete not present
 - 10.2.5. Delete all remotes
- 10.3. Edit remote button
- 10.4. Autolearn remotes
- 10.5. Tx menu locked
- 10.6. Onboard receiver enable/disable

SECTOR controller features >>



Menu 2 - Safety (collision force)

- **Collision force**
 - The collision force can be set independently for raising or lowering from minimum to maximum in five discrete steps. A sixth step will disable collision sensing entirely, allowing **maximum force** to be achieved. The motor will only shut down when its stall point is reached. Stall level is adjustable, refer to Torque Limit under Menu 5.
-  The maximum force setting should only be used if additional safety measures are taken, for example, inductive loops, etc.
- The response of the system to a collision will vary, depending on the **Operating Standard** (eg. CE, UL325*) selected
- *Collision force setting satisfies UL325, but the **SECTOR** barrier itself is not certified
- **Collision count**
 - The number of sequential collisions that the system will allow, before shutting down the controller, if the boom pole does not reach the lowered position. Counter resets each time the boom pole reaches the lowered position. A valid trigger input will clear the shutdown
- **Alarm output**
 - An alarm is activated if the multiple collision shutdown is triggered. This menu item configures the different alarm outputs
- **Lck as ESTOP**
 - Allows the Lck (Holiday Lockout) input to be configured as an emergency stop input
- **External boom status**
 - Generates an output indicating specific states of the boom



Menu 3 - Autolower

- **Autolower status**
 - If enabled, the boom pole will automatically lower after a preset **Autolower Time**
- **Autolower Time**
 - The Autolower Time can be set anywhere from 1 to 240 seconds (four minutes)
- **Autolower Override**
 - Temporarily turn off Autolower. Activate and maintain the memory input for longer than the **Autolower Override Time**. Activate Memory input to clear the override
- **Autolower Advanced Options**
 - Set the conditions under which the boom pole will automatically lower. More than one condition can be selected:
 - **Autolower on Raised** - automatically lower the boom if boom pole is fully raised
 - **Autolower on Partly Raised** - automatically lower the boom pole if it has been stopped partially raised
 - **Autolower on Partly Lowered** - automatically lower the boom pole if it has been stopped partially lowered



Menu 4 - Modes of Operation

Refer to Select operating mode on page 2 for an explanation of the four different Modes of Operation available: Simplex, Complex, PLC and Spike.



Menu 5 - Run profile

- **Lock boom pole at endpoints:**
 - **Lock When Raised** - mechanically lock boom pole in raised position. Use manual override key to override
 - **Lock When Lowered** - as per above for lowered position
-  The locking endstops must be accordingly set for locking to take effect. Refer to installation manual
- **Holding Force** - force used to automatically hold the boom pole in the raised or lowered position if "lock at endpoints" is **not** selected

- **Raise When Mains Fail**
- If enabled, the boom pole will raise in event of a mains power failure. Boom pole will remain raised until mains power is restored
- **Spike Interface**
- If enabled, this facility allows the SECTOR controller to communicate with co-installed roadway spikes, such as CLAWS.
- **Pre-raising Delay**
- Allows a delay between a valid trigger signal and the boom pole raising. Can activate warning light during delay if TVI is not selected. (Refer to pre-flash modes of the Courtesy Light feature, for more details.)
- **Pre-lowering Delay**
- Identical to above, except for boom pole lowering
- **Raising Speed**
- Sets the maximum raising speed in degrees per second
- **Ramp-up Distance**
- Sets the ramp-up distance in degrees
- **Ramp-down Distance**
- Sets the ramp-down distance in degrees of travel of the boom pole when stopping
- **TRG Stop Distance**
- Sets the distance over which a moving boom pole will stop after a trigger signal is received
- **Loop Stop Distance**
- Sets the distance over which a moving boom pole will stop after a safety input is triggered
- **Crawl Distance**
- Sets the final crawl distance in degrees of travel of the boom pole when reaching an endpoint
- **Torque Limit**
- Sets the maximum torque delivered by the motor. This is useful in cases where limited push force is required



Menu 6 - Loop detector

- **ILAC (Inductive Loop Autoclose) Control**
- Causes the boom to Autolower as soon as the closing inductive loop is cleared, ie. the vehicle moves off
- **FRX (Free-exit) Loop Direction**
- Allows a single access point with bi-directional traffic to make use of a free-exit loop. Due consideration must be given to closing and free-exit loop positioning
- **Loop Alarms**
- While the boom pole is lowered, this feature allows the following alarms
 - **Presence Alarm** - Activates an alarm if the closing loop has been continuously activated for a predefined time. The alarm will remain activated while the closing loop is activated
 - **Presence Time** - The time for which the closing loop must be continuously activated before the alarm is activated
 - **Break-in Alarm** - Activates an alarm if the closing loop is activated while the boom is lowered. The alarm remains active while the closing loop is activated, and for a period of 30 seconds thereafter. This time is fixed
 - **Alarm Output** - This menu item configures the different alarm outputs



Menu 7 - TVI (Ticket Vend Interlock) output

Configure TVI output for the specific purpose or as a Courtesy Light. If configured as a Courtesy Light, light will switch on for a timed period every time the boom is activated.

- **TVI Output Polarity**
- Configure output as a normally-closed (NC) or normally- open (NO) contact.
- **The TVI output when configured to courtesy light time**
- The courtesy light time can be set from four seconds to ten hours
- **The TVI output when configured to light profile**



Menu 8 - ChronoGuard (Time-periods)(a world first)

ChronoGuard allows automatic activation or time-barring (prevented operation) of specific controller inputs, and the time-barring of specified remote control buttons used together with the onboard receiver. The Real Time Clock and Calendar will keep time for a minimum of one hour without any power.

• Time-periods

A Time-period is defined by a start and end date and time. Up to 100 Time-periods can be defined. A Time-period can be set as a once-off event, repeated on a weekly or annual basis. The weekly repeat can be chosen to occur on every day of the week, weekdays only, weekends only, or any specific day. The minimum duration of a Time-period is one minute. Once-off Time-periods have the highest precedence, followed by annual and then weekly.

• Auto-functions (Auto-activations)

Activate automatically any of the following inputs/outputs during a Time-period

Inputs

- Barrier Raise
- Barrier Lower
- Barrier Disable (Lck) - also referred to as Holiday Lockout
- Closing Loop (ILD)

Outputs

- Aux Out - this is a switching negative that can be used to drive an external relay for operating any external device
- Aux IO - this is a switching negative that can be used to drive an external relay for operating any external device

• Time-barring

Time-barring of inputs is divided into physical inputs and inputs mapped to a remote control button.

The following physical inputs can be time-barred (prevented from operating) during a Time-period:

- Barrier Raise
- Barrier Lower
- Memory Input (MI)
- Non-memory Input (NMI)
- Barrier Disable (LCK)

The following physical outputs can be time-barred (prevented from operating) during a Time-period:

- TVI (configured as a courtesy light relay)

The following remote control inputs can be time-barred (prevented from operating) during a Time-period:

- Barrier Raise
- Barrier Lower
- Memory Input (MI)
- Non-memory Input (NMI)
- Barrier disable (LCK)



Time-barring of a CENTURION code-hopping transmitter is specified at the time of coding the transmitter into the system. Once an RF input is defined as time-barred, any time-barred transmitter associated with that input will be time-barred during the relevant Time-period. If a physical or RF input is currently time-barred, any attempt to activate it will be acknowledged by a short beep of the onboard buzzer. The input, however, will not activate

• Exclusions

Exclusions are used to prevent scheduled Time-periods from occurring at specific times (eg. public holidays). While time-barring can be used to achieve a similar end, exclusions can also be used to exclude time-barring itself. Each exclusion consumes one Time-period. Exclusions have the highest precedence, followed by time-barring and then Auto-functions



Menu 9 - General settings

- **Operating Standard**

Configure the controller to conform to the specific region's standard - e.g. UL325 or CE.

- **Reset options**

- **Factory Defaults** - Restore only defaults for the operating standard / profile chosen, no other settings affected
- **Delete All Remotes** - Delete all the remotes stored in the system; no other settings affected
- **Reset All** - Clears the controller completely as per an off-the-production-line unit



Boom pole end-of-travel limits are not affected by any reset

- **Diagnostic Screen**

Allows a diagnostic screen to be displayed.

- **Round Test Button**

Disables operation of the round test button on the controller



Menu 10: Remote controls

Learn up to 500 CENTURION remote control transmitter buttons. Using one button as a shift button, each transmitter can operate up to six functions. Each transmitter learned into the system is assigned a unique transmitter ID. When adding transmitters, it is recommended that a record be kept of the ID number allocated by the system to each respective transmitter and the person to whom the transmitter is given. This is necessary should selective deletion be required at a later stage.

- **Press button of valid transmitter**

If the **remote controls menu** has been locked as discussed later, only by pressing a button of a transmitter learned into the system, can this **remote controls menu** be accessed

- **Add Remote**

Any button can be set to control the memory, non-memory, raise boom pole, lower boom pole and Holiday Lockout inputs

- **Delete Remote**

Transmitters can be deleted at any stage according to one of the following:

- **Delete Remote by ID** - Where a record of the unique ID has been kept, delete transmitter according to this
- **Delete Remote Button** - Clear operation of a button on a particular transmitter
- **Delete Remote by Button** - Delete a transmitter that is present
- **Delete-Not-Present** - Allows a Time-period to be set in hours. Any remotes which have not been used in the Time-period will be deleted
- **Delete All Remotes** - Clear the entire remote memory

- **Edit Remote Button**

Move the function from one button to another. The transmitter must be present

- **Autolearn**

Allows a Time-period to be set, during which any specific button will be learned to a specific function when it is pressed. The function will also be activated when the button is pressed. After the Time-period has expired, autolearn is disabled, and no further buttons will be learned.

- **Tx Menu Locked** Lock the "Remote controls" menu and prevent unauthorized addition of new transmitters. Once enabled, the "Remote controls" menu can only be accessed by pressing a valid transmitter button

Diagnosics >>

Diagnostic LEDs

The SECTOR controller has a series of diagnostic LEDs which indicate the state of the inputs. Normally-open inputs are indicated by a red LED, and normally-closed inputs by a green LED. An illuminated red LED indicates that the signal is present (e.g. barrier raise pressed), while a non-illuminated green LED indicates that the signal is absent (i.e. IRB broken)

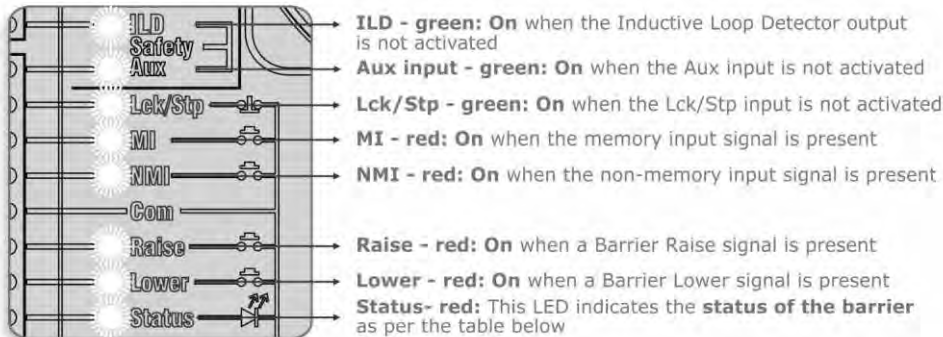

SECTOR barrier status LED

Off	Barrier is lowered
On	Barrier is partially or fully raised
Continuous slow flash	Barrier is raising
Continuous fast flash	Barrier is lowering
One flash every two seconds	Pillar light override is activated
Two flashes every two seconds	No mains present
Three flashes every two seconds	Battery voltage is low
Four flashes every two seconds	Multiple collisions have occurred

FLUX OB (SECTOR termination board) diagnostic LEDs

Power indicator LED

- This green LED is on when power is present, and the controller is functioning

Loop fault indicator LED

- This red LED is illuminated when there is a loop fault. If the loop is open circuit, the Fault LED will flash continuously. If the loop is short circuit, it will remain on

Detection level indicator LEDs

- These five red LEDs provide a visual indication of the Detection Level. Once all five LEDs are on, the detection threshold is almost reached. This is a very useful feature to determine if the loop is going to perform reliably. With no vehicle in the vicinity, all the LEDs should be off

Detect indicator LED

- This green LED indicator is illuminated when there is a vehicle detected. This LED can also be used to determine the loop frequency. Reset or power up, count the number of times the Detect LED flashes. Multiply the number by 10KHz. For example: if the LED flashes eight times, then the loop frequency is approximately 80KHz

LCD display

The SECTOR controller's LCD display shows valuable information regarding the status of the system.

1. Battery icon

Indicates the state of charge of the battery.

- Four solid bars = full capacity
- Two solid bars = 50% capacity
- No solid bars, with the icon flashing = battery empty

2. Mains icon

Displays the presence/absence of mains voltage:

- Plug solid = mains present and battery charging
- Plug hollow and flashing = No mains present and battery not charging

3. Autolower information

- Displays the state of the Autolower function
- Displays off if Autolower is not selected
- OVR if Autolower is overridden, and the remaining Autolower Time if Autolower is active

4. Pillar light/TVI information

- Displays the remaining light time if Courtesy Light Mode is selected
- Pre-flashing Mode is displayed if Pre-flash is selected
- LIT will be indicated if the Pillar Light has been turned on permanently
- TVI will be indicated if the TVI output has been configured

5. Onboard receiver information

Displays the current input being activated by the onboard receiver.

6. Status information

Displays useful information regarding the status of the barrier.

Buzzer feedback

(A warning buzzer will sound (where applicable) as per the table below:)

Inhibitor name	Priority	Number of beeps	Fault type	Barrier continues to operate	User can correct error
Break-in alarm	1	Continuous tone for 30 seconds	Alarm	N/A	N/A
Presence alarm	2	Continuous tone until ILD is cleared	Alarm	N/A	N/A
Battery low	3	3 beeps periodically for 30 seconds	Power system fault	Yes*	Yes
Multiple collision	4	Periodic until condition is cleared by user (500/500ms)	Collision	No	Yes
Auxiliary overload	5	5 beeps periodically for 30 seconds	Hardware	No	No
Holiday Lockout	6	1 beep periodically for 30 seconds	User	No	Yes
Emergency stop	7	1 beep periodically for 30 seconds	User	No	Yes
Time-barring	8	1 beep periodically for 5 seconds	User	No	Yes
No limits set	9	3 short beeps for 5 seconds	Lost	No	Yes
Mains failure	10	2 beeps periodically for 30 seconds	Power system fault	Yes	Yes
ILD broken	11	1 beep periodically for 30 seconds	User	No	Yes
DOSS disconnected	12	5 beeps periodically for 30 seconds	Hardware	No	No
Fuse blown	13	5 beeps periodically for 30 seconds	Hardware	No	Yes
Motor disconnected	14	5 beeps periodically for 30 seconds	Hardware	No	Yes
Bridge damaged	15	5 beeps periodically for 30 seconds	Hardware	No	No
Barrier stalled	16	4 beeps periodically for 10 seconds	Collision	No	Yes

* Barrier will lower and then shut down for two minutes.

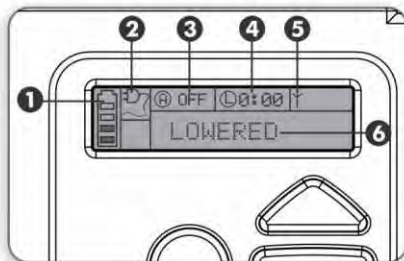

Factory defaults schedule >>

When selecting any feature, the factory default is given on the LCD display. Contact CENTURION for more details.

Fault-finders guide >>

Contact CENTURION for assistance.

Installation handover >>

Explain to the user how to safely operate the SECTOR barrier and the different safety features.



Adding anything to the boom pole, such as signage, will require re-balancing and possibly a different spring. Consult CENTURION for assistance



Sharecall 0860-CENTURION (0860 236 887)
Head Office: +27 11 699 2400

Sharecall Technical Support 0861 003 123 or
+27 11 699 2481
from 07h00 to 18h00 (GMT+2)

(Sharecall numbers applicable when dialed from within South Africa only)



0.07.A.0037_22072013

www.centsys.com