



POLOphone™
INTERCOM

**AUDIO
INTERCOM
SYSTEMS**

System overview & operation

The CENTURION POLOphone is a very versatile intercom system designed for a multitude of applications ranging from a basic 1 to 1 kit to larger installations with up to five components in the system. A component is either an entry panel or a handset as detailed below.

Expandability

The POLOphone system can be configured using combinations of up to five components as follows:

- Up to two entry panels
- Two groups of handsets with up to three handsets per group.
- The system can operate without an entry panel connected.

Each call button rings one or both of the groups of handsets, depending on the mode set. Intercommunication is available between the two groups of handsets.

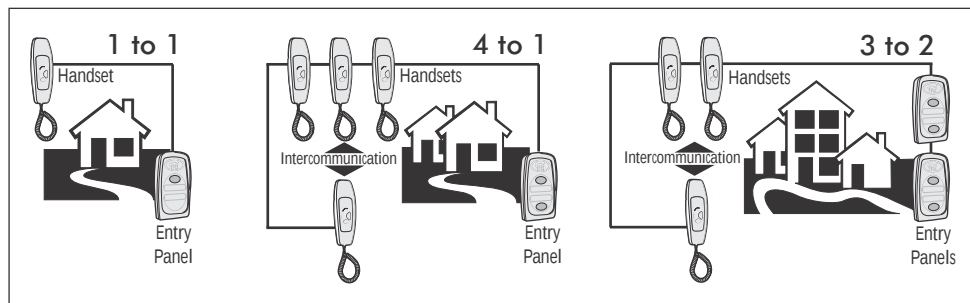

Fig 1 Excellent expandability using only two wires

Wiring

The system uses a two wire bus to link all the components, making the wiring of the system particularly easy.

Powering the system

The POLOphone system operates off a DC supply and can therefore be powered from either a 14V DC mains adaptor or directly from the battery supply of a 12V gate motor system.

The power source can be connected to any component in the system.

Other features

Using the same two wire bus, each handset can independently operate the door lock or gate motor linked to each entry panel. The entry panel is provided with a potential-free, normally-open contact to operate either a gate motor or, in series with a separate power supply, to activate a door lock.

An auxiliary, potential-free, normally-open pushbutton is also provided on each handset. This pushbutton does not connect to the two wire bus and requires separate wiring to operate an auxiliary function on the gate motor or at the entrance such as switching an external light etc.

A fourth button is provided on each handset to call the handsets in the other handset group.

A small window is provided on the face of the handset cradle for the indicator light (LED). The terminals for this LED are on the underside of the cradle circuit board. These can be wired to a gate motor status function etc. Similar to the auxiliary pushbutton, additional wiring is required.

Permanent backlighting of the entry panel call button(s) and identification label(s) are provided.

Operation

When setting up the system the handsets can be split into two groups. Intercommunication can only occur between these groups.

When the call button(s) at an entry panel is pressed it will ring the handset(s) linked to the specific handset group.

The entry panel call buttons can be configured as:

· One-Button entry panel:

Top button (A) and bottom button (B) rings all handsets in the system

· Two-Button entry panel:

Top button (A) rings group "A" handsets

Bottom button (B) rings group "B" handsets

The factory default is a two-button entry panel.

! NB: In a system with two entry panels, a V2 entry panel will only work with a V3 entry panel that has been configured for two-button operation, not one-button operation. V3 entry panels are compatible in either one- or two- button mode.

In an installation with two entry panels the call tone will be different for each entry panel. There will be a simultaneous ring at the entry panel to confirm the ringing at the handset(s).

When lifting the handset, voice communication can take place between the entry panel and the handset. If any of the other handsets in the system are picked up while this communication is taking place, there will be common communication with these handsets.

A dedicated call button is provided on the handset to call the other group of handsets. Any handset in one group will ring all the handsets in the other group. The ring tone is different to that generated when being called from the entry panels so that the user can identify that it is an internal call. If communication is taking place between handsets the entry panels are automatically disconnected to ensure privacy of internal communication.

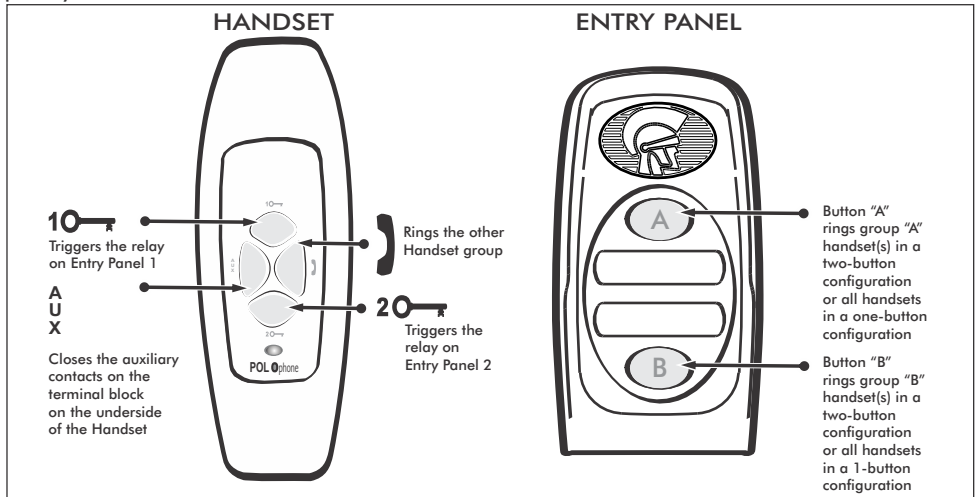

Specifications





Operating Voltage	12 to 14V DC (14V DC if powering handset) Supplied from gate motor DC supply* or separate 14V DC supply
Current draw	Quiescent: 150mA (+/- 60mA for a 1:1 system) Maximum: 200mA
Speech volume	Adjustable at each entry panel and handset
Wiring / Cabling	Two polarized wires for speech, call and gate/door lock release
Ring tone	Electronic while button is depressed, with separate tones when calling from each entry panel in a system or between groups of handsets
Call confirmation at entry panel	Yes
Wiring / Cabling distance	Max 150m - Refer to cable thickness on page 7
Gate / Door release	2A 12V AC/DC Potential-free normally-open contact at entry panel. Door lock requires separate power supply wired in series with contact
Handset auxiliary contact	Potential-free normally-open contact. Requires separate wiring to two wire bus. Contact rating: 2A @ 12V DC/AC
Handset indicator lens	LED terminals on PCB 470Ohm in-line resistor. Requires separate wiring to 2 wire bus.
Entry panel illumination	Call buttons and labels backlit
Operating temperature	-20°C to +50°C
Humidity	0 to 90% non condensing
IP rating	IP56
Surge protection	Yes

* NB: If 12V DC gate motor supply dips when motor starts up and the intercom is being used at the same time, the speech quality might be affected.

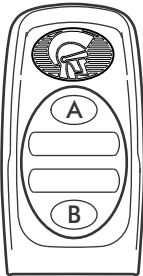
The POLOphone system is supplied as separate components:

- Component 1-Entry panel (with two call buttons) consisting of:



	2 X Mounting screws
	2 X Rawlplugs
	1 X Mounting screw sealing washer
	1 X Cover retaining screw
	2 X Call button labels

- Component 2 -Handset consisting of:

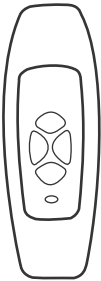

	2 X Mounting screws
	2 X Rawlplugs
	1 X Cover retaining screw
	1 X Telephone cord
	2 X Cable ties

- POLOphone Extras

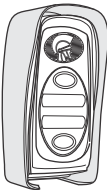

Anti-knock shield

It provides greater protection for the entry panel against vandalism and may be mounted to a gooseneck or directly to a wall or pillar. It is fabricated from 304 grade stainless steel with a brushed finish and enhances the look of the entry panel.

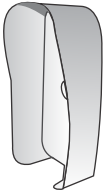

Brushed finish anti-knock shield



Conduit box mounting plate

Simplifies the installation where a conduit wall box has been provided for mounting the handset. The 4" x 2" backing box conduit box mounting plate replaces the existing box plate and provides the necessary fixing points and cable entry hole allowing direct mounting of the handset cradle bracket to it.

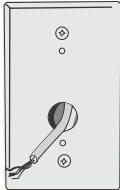

Baseplate



POLOswitch

This dual-function relay card connects to the POLOphone two -wire bus. Depending on the switch setting on the relay card, the POLOswitch functions either to make up an external ring extender for a particular group of handsets or it acts as a secure gate trigger for a particular entry panel.

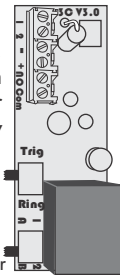

POLOswitch inside motor



14V DC Power Supply

Mains adapter (2 pin). Alternatively use auxiliary 12V supply from gate motor.

Power supply & wiring

Power Supply

The POLOphone system operates off a 14V DC supply. The system is designed so that power can be connected to any one of the components in the system.

If the system is being installed with a gate operator that can provide at least a 12V DC 150mA supply, the entry panel can be connected directly to this unit.

! If the 12V DC gate motor supply dips when the motor starts up and the intercom is being used at the same time, the speech quality might be affected.

Alternatively if battery power is not available at the entry panel, CENTURION offers a 14V DC supply (mains adapter), (order ref: POLOP000V1) that plugs into a universal two pin 220 to 240V AC mains supply socket.

A DC jack is provided on the output of the adapter that plugs conveniently into the cradle of any one of the handsets in the system.

Terminals are provided on the cradle electronic module to terminate a 14V DC supply should the supply being used not have a jack compatible with the socket on the cradle.

If the bus voltage (between terminals "1" and "2") is lower than 8V DC, power needs to be applied at another unit in the system.

Wiring

The two wire bus of the POLOphone system is polarised. If incorrectly connected the unit will not operate, but it will not be damaged.

The length of the bus is limited to a maximum of 150m.

! It might be necessary to double up on the thickness of the two wire bus depending on the distance between the entry panel and handsets in the system, and to which component the power supply is connected (handset or entry panel). Refer to page 7 for the cable thickness schedule.

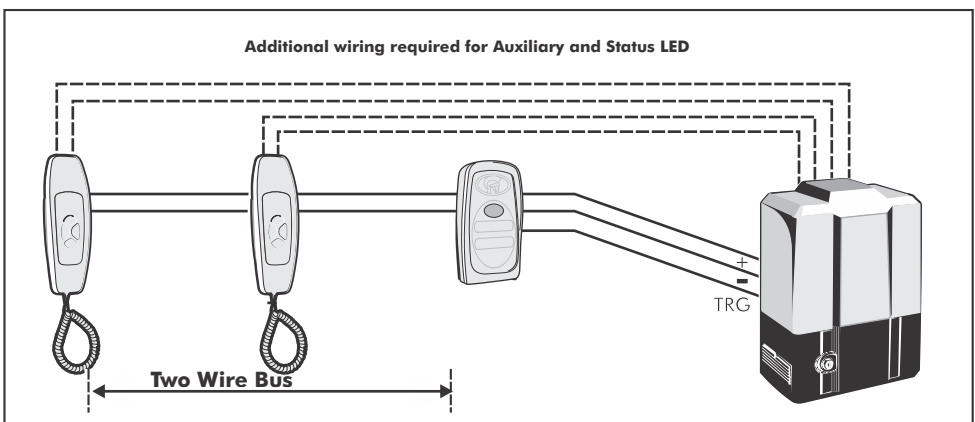

Fig 2 Wiring Requirements





LOCATION OF POWER SUPPLY	FROM COMPONENT	NUMBER OF WIRES	CABLE DISTANCE		TO COMPONENT	LOCATION OF POWER SUPPLY
			<100M	<150M		
PSU 14V DC		TWO WIRES	0,2mm ²	0,4mm ²		
		TWO WIRES	0,4mm ²	0,8mm ²		PSU 12V DC

Fig 3 Cable Thickness Schedule

Door Lock Drive

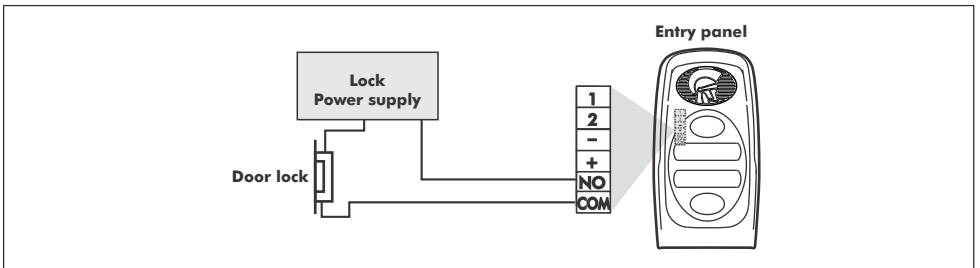

Fig 4 Door Lock Drive

Be Security Wize

How to prevent a would-be intruder from tampering with the wires between the entry panel and gate motor in order to trigger the gate.

Option 1: (Recommended solution)

Benefit:
Connect power to the POLOphone via the POLOswitch - no need to take battery power to the entry panel

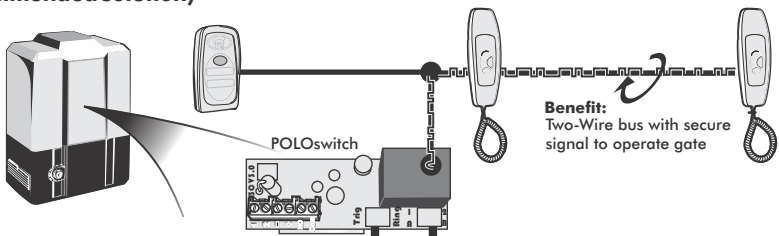

Option 2: (Cheaper solution)

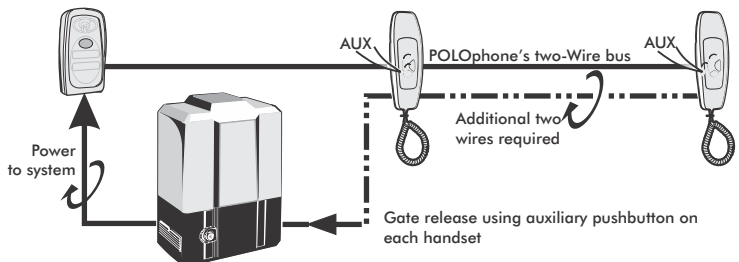

Entry panel installation

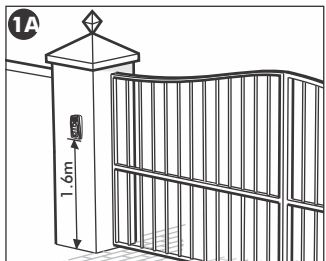

Wall Mount Installation

- Position entry panel on wall adjacent to entrance gate or door
- Mount at a height that allows for comfortably speaking into the microphone
- A recommended height is shown

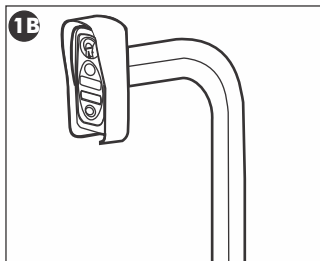

Gooseneck Installation

Alternatively mount the entry panel onto a gooseneck ensuring that:

- The entry panel does not protrude too far into the driveway
- The entry panel is not set too far back and can be easily accessed from a vehicle
- The height allows for comfortably speaking into the microphone

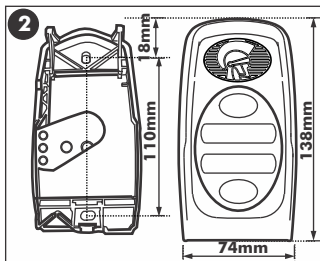

- Dimensions of the entry panel base and mounting holes relative to the entry panel cover

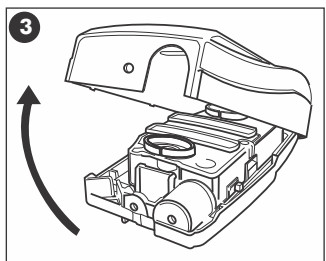

- Lift off the outer cover of the entry panel

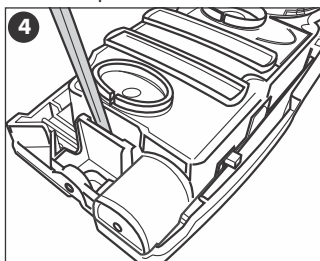

- Insert screwdriver as shown and unclip the electronic module from base

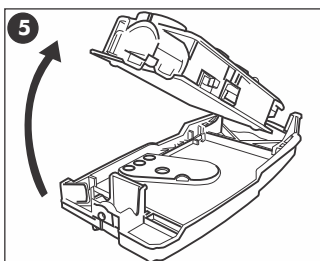

- Lift electronic module off base

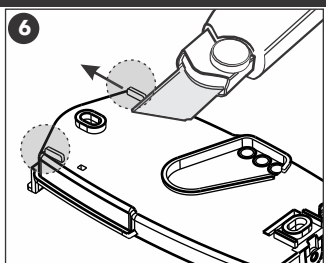

- In the case of an uneven wall, the tabs may be cut as shown to allow the base to 'sit' on the wall without rocking

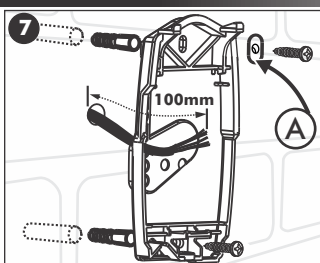

- Hold the entry panel base against the wall at the required height ensuring that it is vertical.
- Mark the location of the mounting holes.

- Using a 6mm masonry bit, drill holes into the wall for the rawlplugs provided in the kit.
- If the cable is being routed into the unit from a concealed conduit behind the base, knock out one of the cable entry holes provided in the base and feed through the cable. Ensure that at least 100mm of cable extends out of the wall.
- Fit sealing washer (A) onto top mounting screw before installing.
- Screw the base firmly into position and using the slots provided in the mounting holes, adjust the base to be perfectly vertical.
- (B) Ensure that sealing washer is fitted and closes off the mounting hole to prevent water ingress.

Entry panel installation

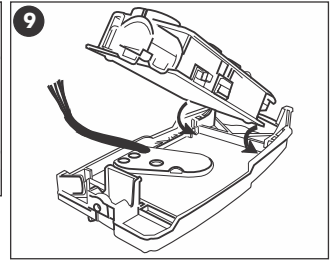
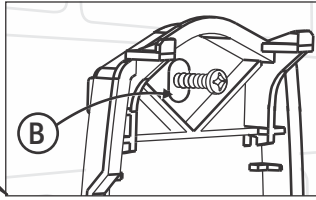
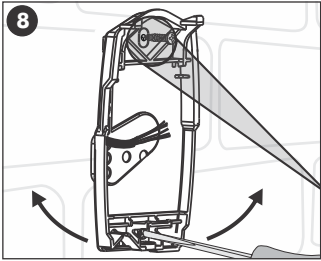

•Hook the electronics module into the base as shown and clip back into position.

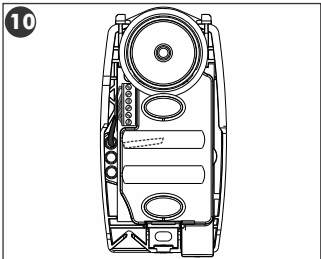

•Terminate cable onto electronics. Refer to wiring diagram (See page 12).

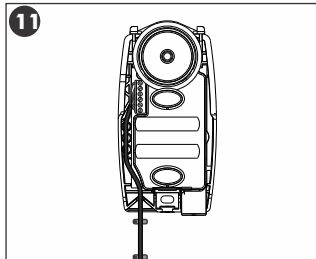

•If the cable is surface mounted, route the cable into the unit from underneath as shown and terminate onto the electronics. Refer to the wiring diagram (See page 12).

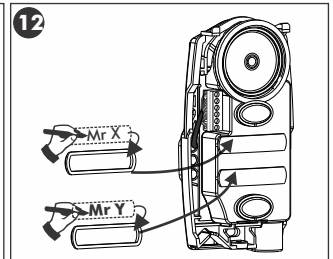

•Write call button labels, insert into lens(es) and clip lens(es) back onto chassis.

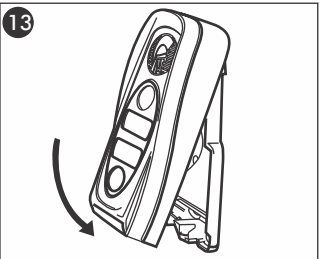

•Clip outer cover back into position.

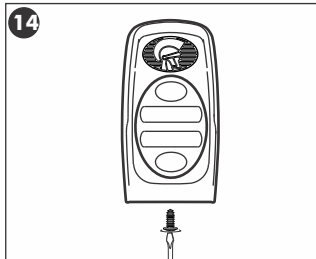

•Secure the cover using the fixing screw provided in kit.

⚠ NB: It will be necessary when commissioning the unit to have

Handset installation

Handset Installation

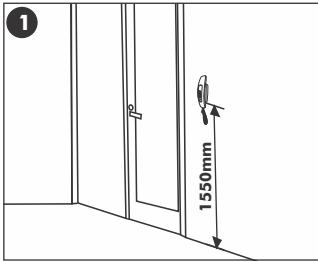

•Position handset on wall where required and at a height that will allow for comfortable use of the handset. A height of 1550mm from the floor to the base of the cradle is recommended.

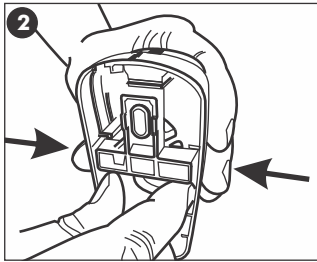

•To remove the cradle base, squeeze the sides of the cradle.

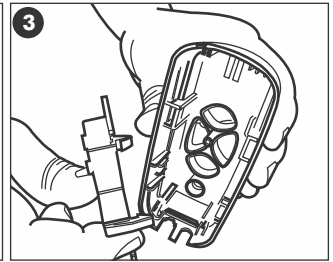

•Extract the cradle base.

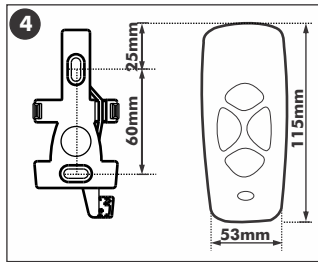

•Outer dimensions of the mounting holes in the cradle base relative to the cradle base.

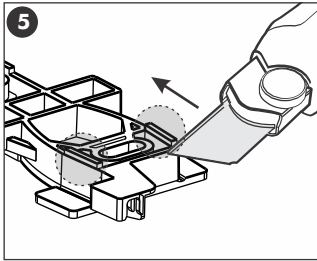

•In the case of an uneven wall, the tabs may be cut as shown to allow the cradle base to 'sit' on the wall without rocking.
(Centurion Systems (PTY) Ltd takes no responsibility for injury, death etc.

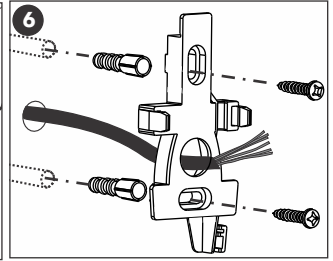

•Hold the cradle base against the wall at the required height and ensure that it is vertical.
•Mark the location of the mounting holes.

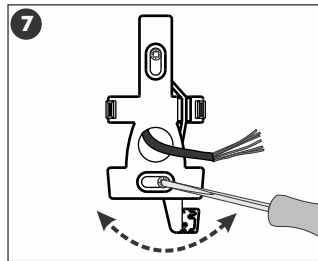

•Screw the base firmly into position and use the slots provided in the mounting holes to adjust the base to be perfectly vertical.

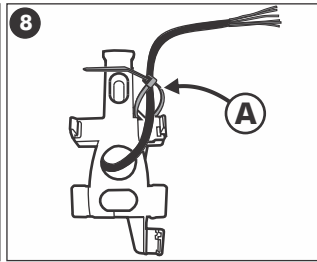

•Route the cable over the channel in the cradle base cross bar and using the cable tie (A) - provided secure the cable to the cradle base as shown.

•Using a 6mm masonry bit, drill holes into the wall for the rawlplugs provided in the kit.
•If the cable is being routed into the unit from a concealed conduit behind the base, route the cable through the cable entry point provided.
•Ensure that at least 140mm of cable

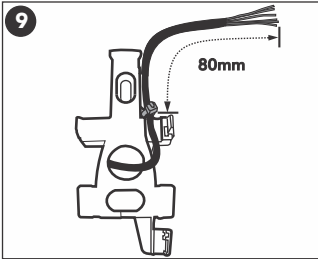

•Tighten cable tie ensuring that there is sufficient slack to terminate the cable onto the electronics ($\pm 80\text{mm}$).

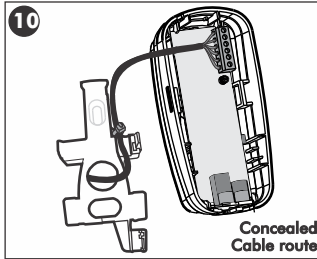

•Terminate cable onto electronics. Refer to wiring diagram (See page 12).

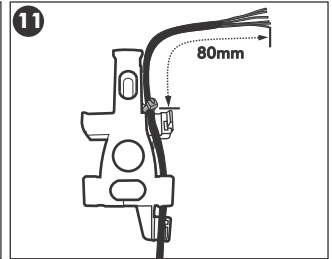

•If the cable is surface mounted, route the cable into the unit from underneath as shown. Secure to cradle base using cable tie provided. Allow sufficient slack ($\pm 80\text{mm}$)

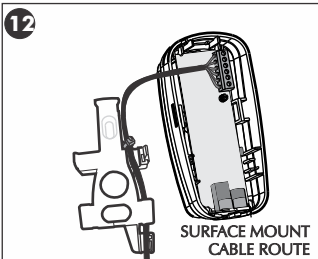

•Terminate onto the electronics. Refer to the wiring diagram (See page 12)

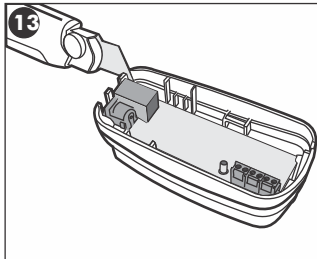

•Using a sharp knife carefully cut out the cable entry slot to allow the surface mounted cable to route into the cradle.

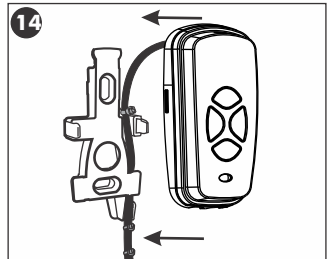

•Clip the cradle back onto the base.

! NB: It will be necessary when commissioning the unit to have the cradle cover removed.

Wiring the status LED

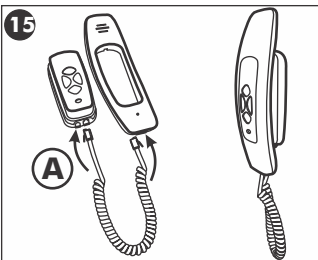

•Clip the (A) long tail end of the telephone cord into the jack provided at the bottom of the cradle and similarly into the handset. Replace the handset onto the cradle.

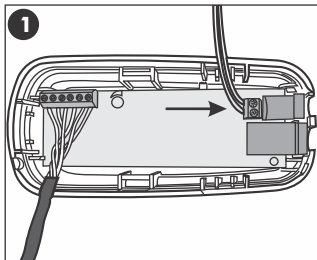

•Connect the wires from the status LED on the gate motor to the terminals.

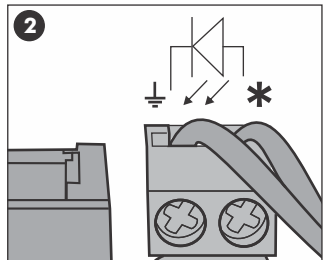

• Insert the wire from the LED drive in the gate motor into the terminal marked with a (*).

• Insert the wire from the COM/- from the gate motor into the terminal marked with a (+).

Wiring diagram

Handset

Entry panel

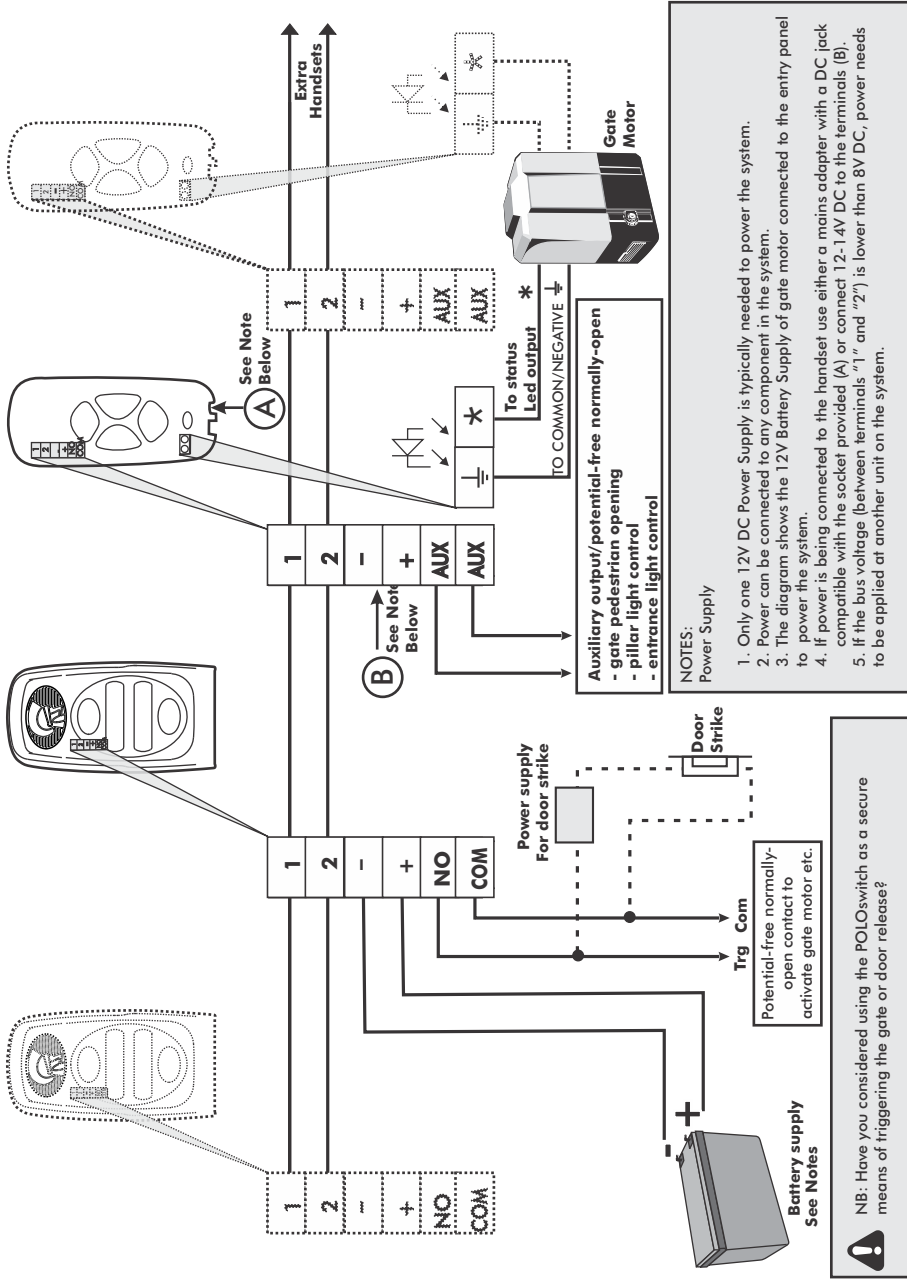

Wiring diagram for poloswitch

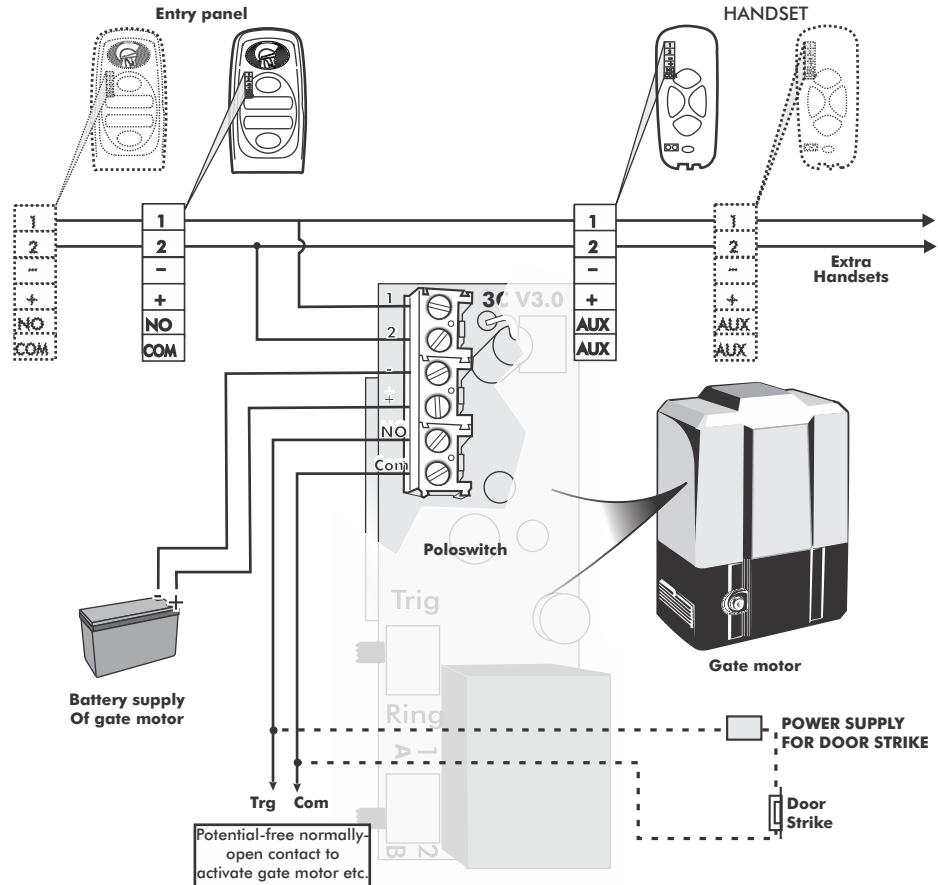

- Two-wire bus with secure signal to operate gate.
- Connect power to the POLOphone via the POLOswitch. There is no need to take battery power to the entry panel.
- An alternative solution is to wire TRG and COM to the Aux terminals on the handset PCB.

Group & Volume Settings

Entry Panel Selector Switch and Volume Control

- If the system has only one entry panel set the selector switch (A) to the upper position or (1). Shown on the next page.
- If there are two entry panels set the selector switch on the one panel to the upper position (1) and on the other panel to the lower position (2).
- When adjusting the speech volume start by pressing the call button to activate the speech on the entry panel.

• Rotates the volume control knob (B) in a clockwise direction.
 • Test the volume by putting the cover back. An acceptable level occurs just before the entry panel howls.

Group & volume settings

- The volume setting depends on the number of handsets connected to the system.

1-or 2-BUTTON Entry panel configuration:

With the entry panel powered up, hold the top and bottom buttons down simultaneously for 5 seconds (5 beeps). After the fifth beep, release the buttons. A confirmation tone will then be heard for 2

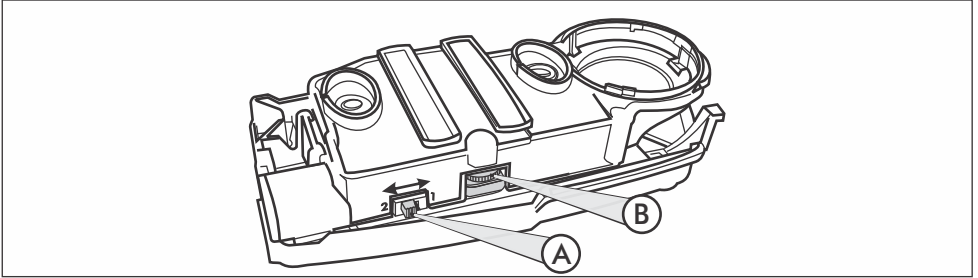

Figure 6 Entry Panel Selector Switch

seconds. The entry panel is now in Configuration Mode, and will be for 10 seconds before it times out.

While in this mode, there are two options available to the user:

- Press the top button (one beep will be heard) to set the entry panel as a one-button unit, where each button rings both groups of handsets

Or

- Press the bottom button (two beeps will be heard) to set the entry panel as a two-button unit, where the top button rings group "A" handsets and the bottom button rings group "B" handsets.

On power up, the entry panel will beep either once or twice to indicate the configuration selected (one beep for a one-button and two beeps for a two-button entry panel)

Handset call group selector switch and volume control

- Each handset is fitted with a selector switch (C) to allow the group number for the specific handset to be set. Set the switch depending on which group, (A) or (B) the respective handset is required to be linked.
- Adjust the speech volume at the handset to approximately 75% by adjusting the control knob (D). Clockwise rotation increases the volume.

Check Functions

- Press the gate/door release pushbutton on each handset and check that the gate/door adjacent to each entry panel operates.

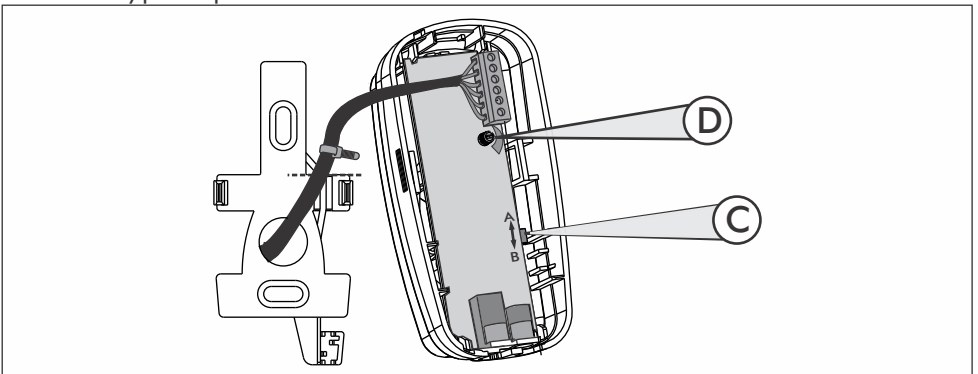

Figure 7 Entry Panel Selector Switch

Fault finding guide

- At each handset press the pushbutton to call the handsets in the other group. Make sure that these handsets ring and that there is communication.
- At each handset check the operation of both the auxiliary pushbutton and the status LED if being used.
- Replace all covers.
- If doing the installation for a client it is recommend when handing over to explain carefully the operation and full functions of the system.

PROBLEM	POSSIBLE CAUSES & SOLUTIONS TO PROBLEM
1 Lights off on Entry Panel	<ul style="list-style-type: none"> • Check polarity of power supply wires. • Check polarity of two wire bus. • Check supply voltage. • Check two wire bus voltage at Entry Panel.
2 Entry Panel howling when active	<ul style="list-style-type: none"> • Reduce volume on Entry Panel.
3 Entry Panel relay not triggering when gate button pressed on Handset	<ul style="list-style-type: none"> • Check correct group (1 or 2) is selected on Entry Panel. • Check bus voltage at Entry Panel
4 Handset not ringing when called	<ul style="list-style-type: none"> • Check polarity of two wire bus. • Check two wire bus voltage at Handset. • Check coil cord connection. • Check that correct group (A or B) is selected on Handset.
5 No speech when handset lifted	<ul style="list-style-type: none"> • Increase volume on Handset. • Check coil cord connection to cradle. • Check hook switch is free to move.



Sharecall 0860-CENTURION (0860 236 887)
Head Office: +27 11 699 2400

Sharecall Technical Support 0861 003 123 or
+27 11 699 2481
from 07h00 to 18h00 (GMT+2)

(Sharecall numbers applicable when dialed from within South Africa only)



0.07.A.0045_22072013

www.centsys.com