

D5-Evo pocket mechanical
installation guide



CENTURION



**LIGHT-
INDUSTRIAL
SLIDING GATE
OPERATOR**

1. Introduction >>

This guide is designed specifically for installers who are familiar with the installation of standard sliding gate motors, but do not know the specifics of the **D5-Evo**.

Always ensure that all the safety instructions described in the installation manual are adhered to during and after the installation process is completed.

2. Important Safety Instructions >>



Please do not proceed with the installation until you have read and fully understand the Safety Instructions included in your product packaging

The Safety Instructions are also available on www.centsys.com, and may also be obtained by contacting Centurion Systems on +27 860 236 887 (RSA only)

3. Icons used in this guide >>

- This icon indicates tips and other information that could be useful during the installation
- This icon denotes variations and other aspects that should be considered during installation
- This icon indicates warning, caution or attention! Please take special note of critical aspects that MUST be adhered to in order to prevent injury**

4. General description >>

The **D5-Evo** is a domestic and light-industrial operator designed to open and close sliding gates weighing up to 500kg. A custom designed gearbox moulded from robust engineering polymers, coupled to a powerful 12V DC motor, provides fast and reliable automation for entrances to homes and small housing estates.

6. D5-Evo identification >>

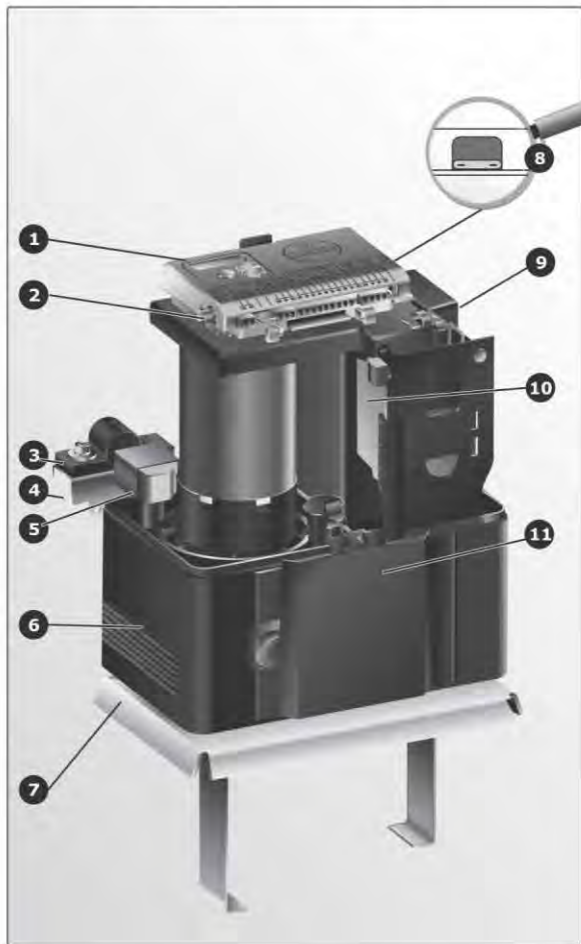

- | | |
|---------------------------------|--------------------------------|
| 1. D5-Evo controller | 7. Foundation plate |
| 2. Courtesy light fuse (3A F/B) | 8. Motor fuse (30A ATO) |
| 3. Gate mounted origin marker | 9. 1 x 12V 7.2Ah battery |
| 4. Origin marker bracket | 10. Switch Mode 2A charger |
| 5. Origin sensor | 11. Manual release access door |
| 6. Side covers | |

5. Technical specifications >>

It is a 12V DC battery operated unit with the following limitations:

Operator push force - starting	30kgf
Operator push force - rated	17kgf
Gate mass - maximum	500kg
Gate length - maximum	100m
Maximum numbers of operations per day	150
Degree of protection	IP54

7. Preparation of site >>

General considerations for the installation

For comprehensive information, please refer to the full installation manual available for download on www.centsys.com

Install the gate operator only if:

- It will not pose a hazard to the public
- There is sufficient clearance to a roadway and/or public thoroughfares
- The installation will meet all municipal and/or local authority requirements once completed
- The gate mass, length and application is within the operator specifications
- The gate is in good working order, meaning:
 - That it moves freely
 - Does not move on its own if left in any position
 - It can be installed to have sufficient clearance between moving parts when opening and closing to reduce the risk of personal injury and entrapment
 - Pushbuttons or keyswitches, when required, can be positioned so that the gate is in line of sight of the operator

Make sure the gate mass, starting - and rated-pull-force limitations are not exceeded.



Typical anti-lift arrangements

Guide-rollers must ensure that the gate is held vertically through the entire length of the gate travel. For improved safety fit additional support posts to prevent gate from falling over if guide-rollers fail.

Ensure that the gate cannot be lifted off the motor pinion with the anti-lift bracket fitted

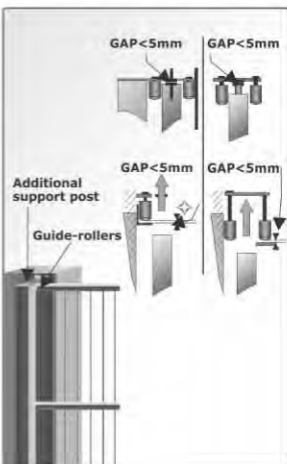

Endstops

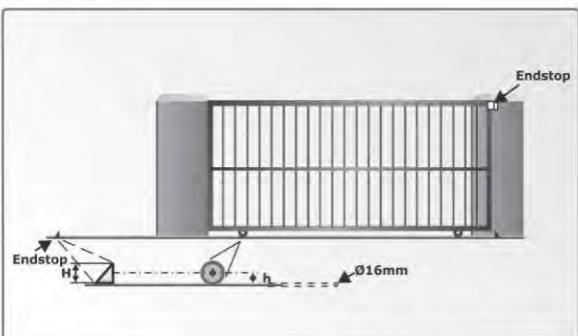

Fit endstops capable of stopping the gate at rated speed



Make $H > h$ to ensure gate will not jump over endstop as shown above

8. Lubrication >>



Do not attempt to run the operator without first filling the gearbox with lubricant

Oil filling procedure

1. Lift the cover of the operator.
2. Remove the battery so that you can gain access to the coloured filler plug.
3. Remove the coloured oil filler plug by levering it out with a screwdriver.
4. Empty the contents of the oil bottle into the gearbox (80ml).
5. Refit the coloured oil filler cap.

Oil specificationsCEN
product code:
OIL80ML0X0/H
Castrol SAF-XO 75W-90 Synthetic Final Drive Lubricant

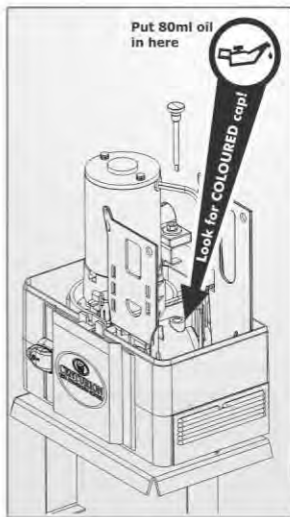

9. Cabling requirements >>

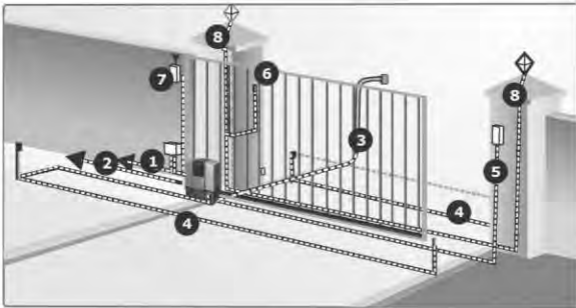

Legend

1. 220V - 240V AC mains cable via double pole mains isolator switch (3 core LNE 1.5mm² SWA) * ☆

Optional wiring (all cable is multi-stranded):

2. Intercom cable from motor to dwelling (n1 + 6 core 0.5mm²) ❖
3. Intercom cable from motor to entry panel (n2 0.5mm²)
4. **Safe Close and Safe Open:** Recommended infrared safety beams (3 core 0.5mm²)
5. **Trg:** Access control device (3 core 0.5mm²)
6. **Ped:** Optional pedestrian keyswitch (a) OR keypad (b) (3 core 0.5mm²)
7. **Trg:** Optional external radio receiver (3 core 0.5mm²) ❖
8. **Light:** Optional pillar lights (3 core LNE SWA, size according to power requirements)

n1 = number of cores required by intercom

n2 = number of cores required by intercom

* Possibly increase cable thickness if pillar lights are installed

☆ Type of cable must adhere to municipal bylaws but typically SWA (steel wire armoured) cable is recommended. The armouring provides excellent screening, which gives better protection against lightning – earth one end of the screening)

❖ Allows for all features such as pedestrian opening, status LED, etc., to be operated from the intercom handset inside the dwelling. Number of cores and type of cable could vary depending on brand of access control system being used

❖ For optimum range, an external receiver can be mounted on the wall

10. Manual operation >>

Disengage gearbox/drive

1. Insert the camlock key and rotate it 90° **clockwise**. This will allow for the removal of the cover, as well as for the rotation of the release thumbwheel.

Do not remove the thumbwheel. Removal of the thumbwheel may result in water entering the gearbox and the warranty will be void



2. Rotate thumbwheel clockwise until gearbox releases and gate can be moved manually.
3. If the gearbox must be left in manual mode for an extended period of time for whatever reason, it is recommended that the access door is locked. This secures the cover and prevents access to the inside of the unit, which contains high voltages. It also prevents theft of any components and provides full protection from the elements.



Re-engage gearbox/drive

1. Rotate thumbwheel anti-clockwise until thumbwheel feels loose in the hand. Make sure that the manual override access door can be closed.
2. Slide gate until gearbox/drive engages. Never run the motor before the unit is engaged.



11. D5-Evo operator installation >>



Ensure that all the standard considerations for a quality gate installation are adhered to as detailed in CENTURION's detailed installation manuals. These must include:

- Correct access in and out of the premises
- Endstops are mandatory and must be capable of stopping the gate at rated speed
- Guide-rollers and anti-lift brackets are correctly fitted
- The gate mass, starting- and rated-pull-force limitations are not exceeded
- The **D5-Evo** is positioned correctly and does not protrude into the driveway

Locate operator position

A: Above pinion - Raz rack

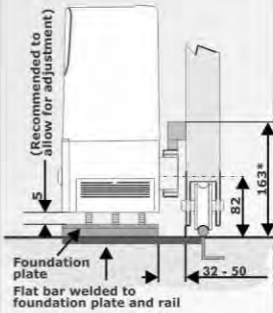

* Includes 3mm clearance required between rack and pinion

B: Above pinion - Steel rack

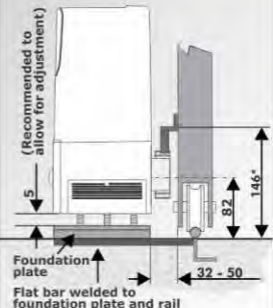

* Includes 3mm clearance required between rack and pinion

1. To ensure operator does not protrude into driveway, install base plate at least flush with the driveway entrance.
2. Determine a suitable position and vertical height for the operator by considering Figures A, B and C.

C: Above pinion - Nylon angle rack

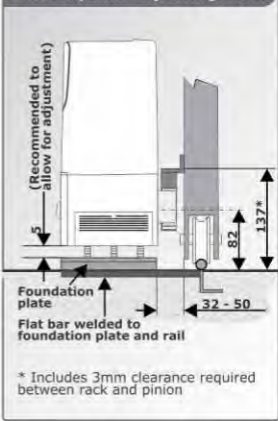

- With careful selection of the rack configuration, and operator vertical height, mounting of the rack could in some cases be greatly simplified
- If a theft-resistant cage is required, be sure to leave enough clearance from pillars, etc.
- If using nylon angle rack please ensure that the weight and pull force of the gate do not exceed the strength limit of the rack

Foundation plate installation

The foundation plate can either be set into a concrete foundation, or bolted down onto an existing concrete plinth, refer to illustrations below.

Option 1:

New concrete foundation

Assemble foundation plate with anchor brackets as shown in the illustration.



- Ensure that the M10 gearbox mounting bolts are properly tightened
- Cable conduits must be installed before pouring the concrete

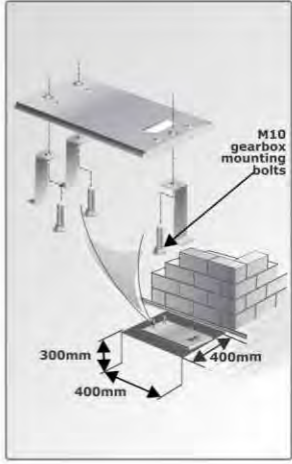

Option 2:

Bolting foundation plate onto an existing concrete plinth

If bolting onto an existing concrete plinth, place the foundation plate down in the correct position and use the plate as a template for marking the rawl bolt holes.

Assemble foundation plate without anchor brackets before bolting down onto plinth.



- Ensure that the M10 gearbox mounting bolts are properly tightened

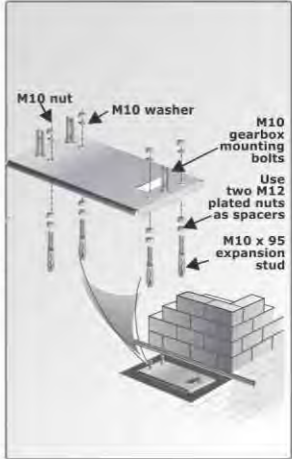

Route cables and secure foundation plate

1. Route cables as determined in Section 9, Cabling requirements.



Make sure that all cables protrude at least 400mm above the baseplate once installed as shown in the illustration

2. Securely concrete or bolt the foundation plate in position.

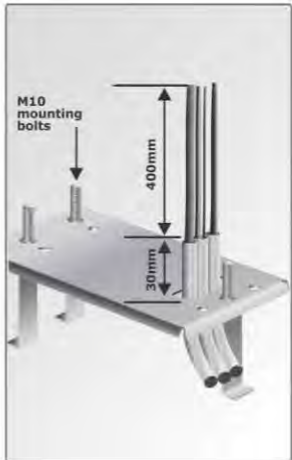

Mount the gearbox

3. Remove the knock-outs for the cables from the gearbox.
4. Feed the cables through these holes while fitting the gearbox to the baseplate.
5. Note how the cables route up onto the control card.
6. Check that the operator is level.
7. Secure the gearbox in place fitting the following in sequence: first a nut and then a washer onto each gearbox mounting; then the gearbox; and then a washer followed by a spring washer and finally a nut onto each gearbox mounting.
8. Do not mount gearbox flat down onto mounting plate. Adjust the height of the mounting nuts to raise the gearbox at least 5mm above the plate. This is to allow for later adjustments.
9. Seal the conduit and knock-out holes in the operator with silicone sealer to prevent ants from entering the operator through these cable entry points.

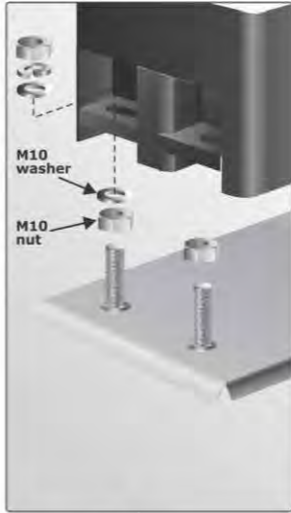
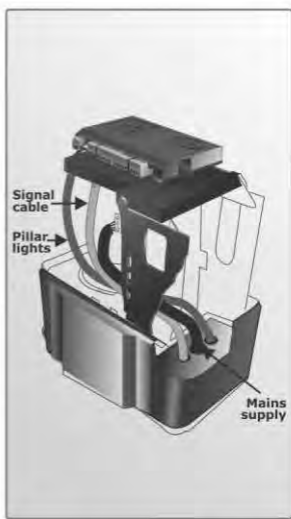

Mount the rack

The rack must be securely mounted to the side of the gate. It must be parallel with the gate rail, and there must be a 2 - 3mm gap between the teeth of the pinion and the rack, along the entire travel of the gate

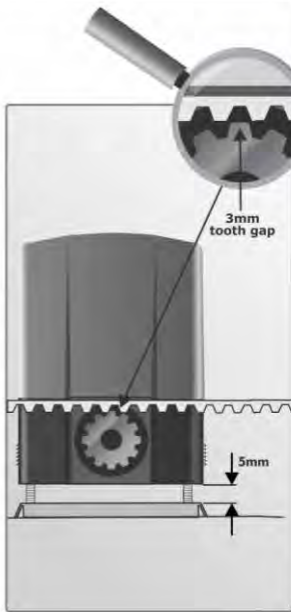

Steel rack

1. Fix rack using the steel angle brackets provided.
2. Brackets must be spaced no more than 300mm apart.
3. When joining different lengths of steel rack, a simple way of ensuring correct pitch spacing, is to clamp a small off-cut between the two pieces.

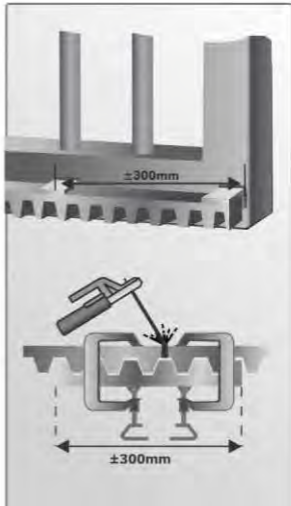

RAZ rack

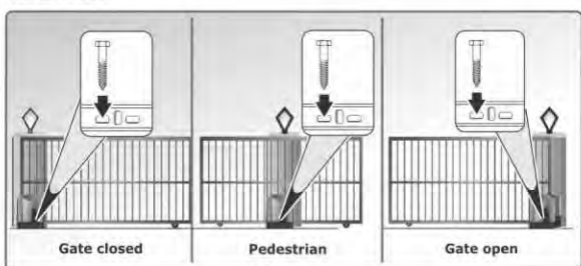

1. Use at least three TEK screws per half metre section of rack.



Fit additional fixing screw through the horizontal slots to secure the rack to the gate directly above the pinion when the gate is in the closed, pedestrian and open positions

Mounting the origin marker

1. Close the gate completely.
2. Mount the origin marker to the rack a minimum of 500mm from the origin sensor.

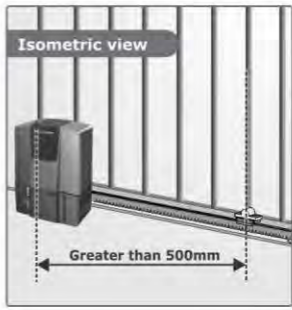

Steel rack

3. For steel rack mount the origin marker onto the rack using the bracket provided.
4. Weld the bracket to the rack.
5. Bolt the origin marker onto the bracket using the fasteners provided.

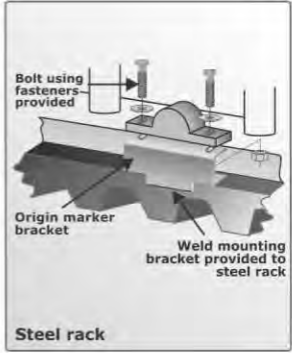

RAZ rack

6. With RAZ rack the origin marker mounts directly on top of the rack without a bracket.
7. Drill mounting holes directly into the rack and bolt into position.
8. File away the front lip of the rack if you need to move the origin marker closer to the operator as the gate slides past.

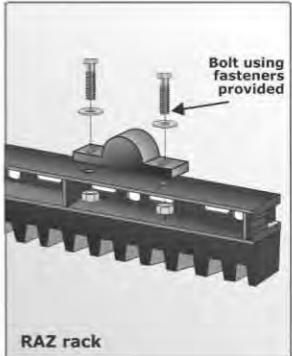

Nylon angle rack

9. With nylon angle rack it is necessary to use the bracket provided.
10. It is preferable to use self-tapping fasteners to secure the bracket into the side of the nylon rack as shown.
11. Make a small tack weld to secure the back of the bracket onto the angle iron section of the rack.
12. Bolt the origin marker onto the bracket using the fasteners provided.

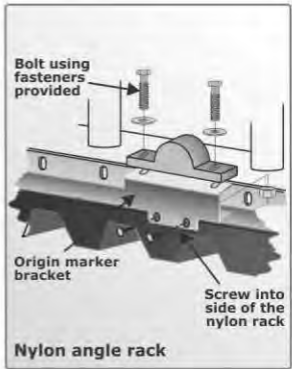

Mounting the origin marker (continued)

13. Manually slide the gate OPEN until the origin marker is in line with the origin sensor.

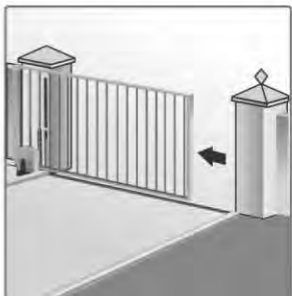

14. Ensure distance between face of marker and front face of sensor is between 13mm and 20mm.

Take care with the orientation of the arrow on the origin marker. This arrow must face the operator

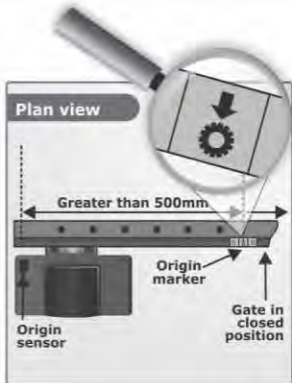

15. Adjust distance by sliding the origin marker along the slotted mounting holes until the specified distance is achieved.

For best results keep gap between marker and sensor as small as possible

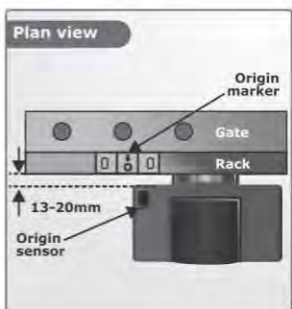

It is possible to make the distance between the marker and the sensor much greater than 500mm. However, if using the pedestrian opening facility, although the position of the marker will not affect the width of the pedestrian opening, it is preferable to have the marker mounted inside of the pedestrian opening point

Apply warning decal/signage

Apply the supplied Warning! decals/signage to the gate



12. Basic maintenance >>

CENTURION operators are designed to be maintenance-free. However, there are some basic checks that should be carried out regularly, (every six months). These checks will increase the long term reliability of the system and prevent erratic operation of your gate.

Isolate mains supply as well as disconnecting the battery before cleaning or working on the equipment.

General

- Keep the track clear of stones, dirt and obstructions
- Ensure that all rollers run freely
- Put the operator into Manual Mode and check that the gate runs freely on its rail and does not catch or foul against the walls or pillars
- Ensure that the gate wheels and guide-rollers are rotating freely and are not worn. In high-volume applications it will be necessary to replace these components regularly
- Ensure that the rack is properly secured to the gate and that it does not press down onto the operator pinion at any point along its travel
- Keep shrubs and vegetation clear of the motor and rack
- Check that the key still operates the camlock - spray with lubrication if necessary
- Keep the inside of the motor housing clear of insects and dust

Battery

CENTURION operators, which are fitted with maintenance-free lead acid batteries, should provide at least three years of normal service life.

For sites utilising an external large capacity (+/-35Ah) low maintenance battery, ensure that the level of liquid (electrolyte level) is correct.

In all instances check for corrosion of the battery terminals. Clean and apply copper-based grease as necessary.

Charger

The **D5-Evo** operator has a charger separate to the main controller. In the case of product malfunction, the charger fuse should be checked, but only by a qualified electrician. Always isolate the mains supply to the operator before attempting to remove and check the fuse.

Check the "Mains Present" icon on the main diagnostic screen or switch to the battery charger diagnostic screen and check the charger voltage - right hand value. This should indicate, 13.8V for the **D5-Evo**. Each charger has a red light (LED) to indicate mains supply.

Gearbox Oil Level

Check the oil level as described in section 8 of this document or refer to the online manuals on our website, (www.centsys.com).

Alternatively, please contact your CENTURION installer for assistance

13. Installation handover >>

Once the installation has been successfully completed and tested, it is important for the installer to explain the operation and safety requirements of the system.

NEVER ASSUME THE USER KNOWS HOW TO SAFELY OPERATE AN AUTOMATED GATE!

Even if the user has used one before, it does not mean he knows how to SAFELY operate it. Make sure that the user fully understands the following safety requirements before finally handing over the site.

The following needs to be understood by the user:

- How to operate the manual release mechanism.
(Show them how by demonstration)
- How the obstruction detection and all other safety features work.
(Show them how by demonstration)
- All the features and benefits of the operator, i.e. Safety beams, ChronoGuard, etc.
- **All the safety considerations associated with operating an automated gate. The user should be able to pass this knowledge on to all other users of the automated system and must be made aware of this responsibility.**



- **Do not activate the gate operator unless you can see it and can determine that its area of travel is clear of people, pets, or other obstructions**
- **NO ONE MAY CROSS THE PATH OF A MOVING GATE. Always keep people and objects away from the gate and its area of travel**
- **NEVER LET CHILDREN OPERATE OR PLAY WITH THE GATE CONTROLS, and do not allow children or pets near the gate area**
- **Be careful with moving parts and avoid close proximity to areas where fingers or hands could be pinched**
- **Secure all easily accessed gate operator controls in order to prevent unauthorized use of the gate**
- **Keep the automated gate system properly maintained, and ensure that all working areas are free of debris and other objects that could affect the gate operation and safety**
- **On a monthly basis, check the obstruction detection system and safety devices for correct operation**
- **All repair and service work to this product must be done by a suitably qualified person**
- **This product was designed and built strictly for the use indicated in this documentation. Any other use, not expressly indicated here, could compromise the good condition/operation of the product and/or be a source of danger!**

CENTURION SYSTEMS (Pty) Ltd. does not accept any liability caused by improper use, of the product, or for use other than that for which the automated system was designed.

Ensure that the customer is in possession of the User Guide and that you have completed the installation details in the back of the User Guide.



CENTURION

Sharecall 0860-CENTURION (0860 236 887)
Head Office: +27 11 699 2400

Sharecall Technical Support 0861 003 123 or
+27 11 699 2481
from 07h00 to 18h00 (GMT+2)

(Sharecall numbers applicable when dialed from within South Africa only)



0.07.A.0046_22072013

www.centsys.com