

R3 and R5 user guide



CENTURION



ROTARY SWING GATE OPERATOR

Table of Contents

Company Profile	3
Introduction	4
Safety Instructions	4
Principles of Operation	5
Features & Functions	6
Introduction	6
Modes of Operation	6
Standard Mode of Operation	6
Radio Transmitter	6
Intercom Pushbutton	7
Reversing Mode	7
Condominium Mode	7
PIRAC Mode	7
Pedestrian Keyswitch (Optional)	8
Anti-crushing Device	8
Multiple Collision	9
Automatic Closing	9
Auto-close Override	10
Protection Beam	10
Gate Status Indication	11
Battery Low Protection	11
Security (Courtesy) Light Timer	12
Pre-flashing	12
Holiday Lock-out	12
Lightning Protection	13
Alternative Power Supply	13
Solar Panel	13
Manual Release	13
Basic Maintenance	16
Specifications	18
Troubleshooting Guide	19
Product Guarantee	23

Company Profile

CENTURION SYSTEMS has been manufacturing automatic gate systems since 1987, and is committed to providing reliable, cost effective solutions in the field of access automation.

CENTURION strives to give service and backup second to none. Our engineers are available to give sales support, installation training, and answers to technical or installation problems.

The equipment is installed worldwide and is available through a network of distributors.

CENTURION is an ISO 9001 registered company, continually looking at updating its products in line with world trends to ensure that its products will provide customer satisfaction.

Further information is available on our web site www.centsys.co.za



© CENTURION SYSTEMS (PTY) LTD 2007

Centurion Systems (Pty) Ltd. reserves the right to make changes to the products described in this manual without notice and without obligation of Centurion Systems (Pty) Ltd. to notify any persons of any such revisions or changes. Additionally, Centurion Systems (Pty) Ltd. makes no representations or warranties with respect to this manual.

No part of this document may be copied, stored in a retrieval system or transmitted in any form or by any means electronic, mechanical, optical or photographic, without the express prior written consent of Centurion Systems (Pty) Ltd.

Introduction

A CENTURION GATE AUTOMATION system is a quality product designed to give many years of trouble free use, provided it is correctly installed and maintained.

This guide highlights the features and operation of the CENTURION R3 and R5 AUTOMATIC SWING GATE systems to ensure that, YOU, the user will get the most from your system.

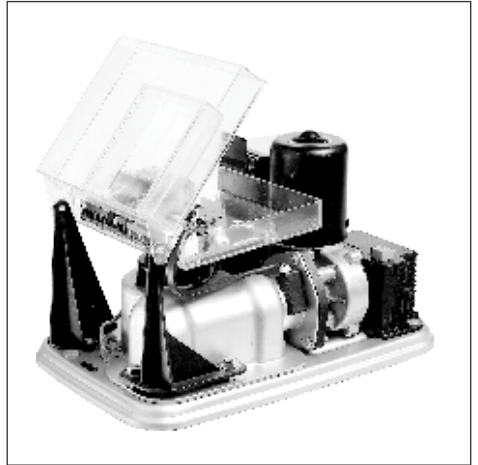

Safety Instructions

Even if you have used an automated gate before, please read through the Safety Instructions carefully. Make sure that you fully understand the following safety requirements before finally operating the automated gate.

Ensure that you fully understand:

- How to operate the manual release mechanism. *
 - How the obstruction detection and all other safety features works. *
 - All the safety considerations associated with operating an automated gate, and that you understand the importance of explaining these safety instructions to all other users of the automated system:
1. Do not activate your gate opener unless you can see it and can determine that its area of travel is clear of people, pets, or other obstructions.
 2. **NO ONE MAY CROSS THE PATH OF A MOVING GATE.** Always keep people and objects away from the gate and its area of travel.
 3. **NEVER LET CHILDREN OPERATE OR PLAY WITH THE GATE CONTROLS,** and do not allow children or pets near the gate area.

-
4. Be careful with moving parts and avoid close proximity to areas where fingers or hands could be pinched.
 5. Secure all easily accessed gate opener controls in order to prevent unauthorized use of the gate.
 6. Keep the automated gate system properly maintained, and ensure that all working areas are free of debris and other effects that could affect the gate operation and safety.
 7. On a monthly basis, check the obstruction detection system and safety devices for correct operation.
 8. All repair, and service work to this product must be done by a suitably qualified person.
 9. This product was designed and built strictly for the use indicated in this documentation. Any other use, not expressly indicated here, could compromise the good condition/operation of the product an/or be a source of danger.
 10. Centurion Systems does not accept any liability caused by improper use of the product, or for use other than that for which the automated system was intended.

Principles of Operation

The CENTURION R3 and R5 rotary swing gate operators are both powered by a 12V DC motor using a maintenance free, lead acid battery as the primary power source. The battery is charged via a 220V mains supply or a solar panel. The major benefit of this philosophy is uninterrupted operation of the gates even in the event of a mains power failure. For light industrial applications the R3 and R5 operators are both available with a power-pack which can deliver the full current draw of the 12V DC motor. If battery back-up is required, a battery is fitted in a separate enclosure. The capacity of the battery is determined according to the number of operations required in the event of a power failure.

An independent motor drive unit operates each leaf of the gate. Both single and double leaf systems are available. The MASTER operator and the SLAVE operator where applicable consist of a high torque geared DC motor driving through a main reduction unit onto an output shaft. The output shaft is linked to the gate via an articulated arm secured by a padlock. The drive units are self-locking preventing the gates from being forced open.

The electronic controller, charger and maintenance free battery (7A/H) are housed inside the MASTER motor of the system only. The electronic controller, which co-ordinates the operations of the drive units, is further protected by a plastic enclosure inside the MASTER operator. For added reliability the controller is fitted with advanced lightning protection based on circuitry, designed and tested in conjunction with the CSIR.

The drive unit uses an innovative internal position control system with origin, to track the movement of the gate and accurately set the "open" and "close" positions.

Each operator are fitted with an internal manual override release.

Features & Functions

Introduction

The R3 and R5 Rotary arm operators are fitted with the CP75 controller. The controller synchronizes the functions of the gate operator.

Modes of Operation

There are four different modes of operation that can be selected. Only one mode can be selected at any one time.

STANDARD (with selectable auto close* feature)

REVERSING (with selectable auto close* feature)

CONDOMINIUM (compulsory auto close*)

PIRAC (compulsory auto close*)

STANDARD MODE is the most common. The other modes are usually used for specialist applications.

**The auto-close feature is described under the section "Automatic Closing"*

STANDARD MODE OF OPERATION

The gates are opened in the following way:



Hand held transmitter sends coded signal

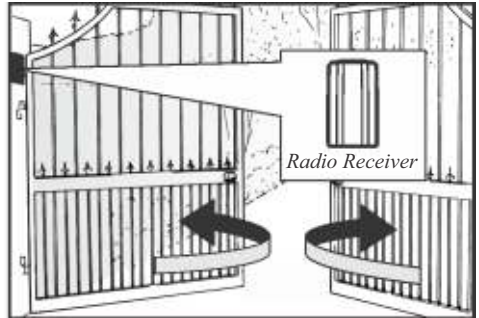

Receiver uses signal to open or close the gate

Radio Transmitter

A hand held radio transmitter, carried in the motor vehicle, sends a coded signal to the receiver mounted in the control enclosure to open or close the gate.

- Press once for approximately 1 second to get the gate into motion.
- If the transmitter is pressed while the gate is either opening or closing the gate will immediately stop. Pressing the button again will cause the gate to reverse.

If the automatic closing facility has been selected, and the gate is **closing** automatically, then the gate will stop and stay in that position if the transmitter is pressed. Pressing the button again will cause the gate to reopen.

If the gate is **opening** with the automatic closing facility selected, and the transmitter is then pressed, the gate will stop, but will close automatically after the auto-close delay time.

Intercom Push button (Optional)

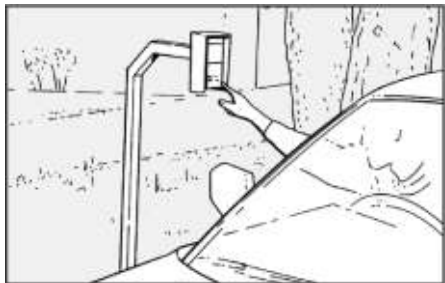

A visitor outside the gate requests entrance

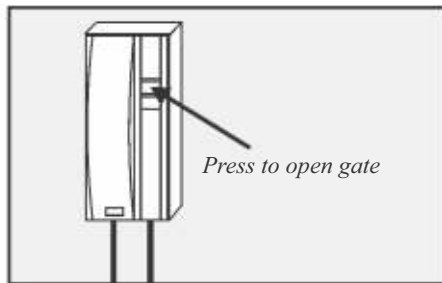

Gate opened from intercom pushbutton inside house

Most automatic gate installations are fitted with an intercom which provides for communication between the house and the gate.

The intercom handset is usually provided with a GATE or DOOR RELEASE pushbutton which, when pressed, sends a signal to the gate controller to open the gate.

The sequence of operation of this pushbutton is identical to the operation when using the radio transmitter as described above.

REVERSING MODE

The system offers an alternative mode of operation to the above. Referred to as reversing mode, if the transmitter is pressed while the gate is moving, the gate will automatically reverse direction. This mode offers greater security than STANDARD mode as the gate can never be left in a midway position.

CONDOMINIUM MODE

The system can be set for CONDOMINIUM operation. This facility is designed for greater safety and security, in applications where there will be a number of users, such as the entrance to a townhouse estate, factory or office park.

In CONDOMINIUM mode the gate is opened by pressing the pushbutton on the remote transmitter or intercom. If the system is re-triggered while the gate is opening, the signal is ignored and the gate will continue to open. The gate closes automatically as per the AUTO-CLOSE facility described later in this user guide. In CONDOMINIUM mode the AUTO-CLOSE cannot be overridden. If the remote transmitter or intercom pushbutton is pressed while the gate is closing the gate will immediately reopen.

The gate cannot be stopped in a midway position and will therefore always close.

If the gate is triggered while the gate is in the open position, the AUTO-CLOSE timer is reset.

 **NOTE:** It is highly recommended that a protection beam be used in conjunction with this facility to prevent the AUTO-CLOSE from closing the gate onto a vehicle passing through.

PIRAC (PASSIVE INFRA RED AUTO-CLOSE)

This facility is an extension of the CONDOMINIUM facility described above. It is designed for applications

requiring greater security as the gate closes immediately behind the vehicle or person passing through.

PIRAC will operate only if a protection beam or other type of vehicle detection system (e.g. inductive loop) has been fitted.

The remote transmitter or intercom pushbutton will only open the gate. As a vehicle drives through the entrance it activates the protection beam and as soon as the vehicle clears the beam, the gate will close immediately, even before it is fully open.

If the gate reaches the fully open position without the beam being activated the gate will wait the AUTO-CLOSE time and then re-close. If, however, a vehicle passes through the entrance activating the beam, the gate will close the moment the vehicle has cleared the beam regardless of the AUTO-CLOSE time.

Pedestrian Keyswitch (Optional)

The pedestrian keyswitch is typically fitted to the gate pillar. Its purpose is to open the gate a limited amount for pedestrians. In the case of a double leaf system only the MASTER gate will open.

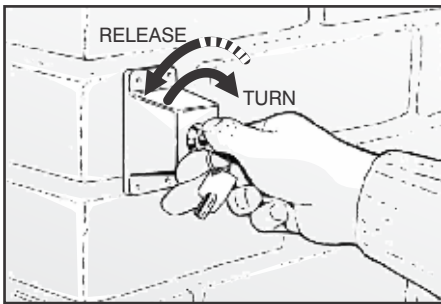

Pedestrian Keyswitch

- Fit key into keyswitch and turn key clockwise as though starting a motor car.

- Let the key spring back to rest position and remove key immediately.

To allow time for removal of the key, there is a 2 second delay before the gate begins to open. If the courtesy light (refer section, "Security / Courtesy light timer") is connected to the control card, it will flash twice, indicating that the gate will open approximately 1 metre and then stop. After 5 seconds the gate will automatically close.

The gate can be held open by keeping the key turned in the keyswitch. As soon as the key is released back to its normal rest position the gate will close after the 5 second delay.

If a protection beam has been fitted (refer section "Protection Beam"), and the beam is broken while the gate is closing, the gate will stop and re-open to the pedestrian opening point. The gate will remain in that position while the beam is broken and only close 5 seconds, or whatever the pedestrian auto-close time has been set to, after the beam has been cleared.

(The opening distance and the time that the gate remains open can be adjusted to suit. Default values are described above)

Anti-crushing Device

The R3 and the R5 operator incorporates an electronic anti-crushing mechanism that will sense if a person or vehicle has obstructed the gate.

If the anti-crushing mechanism of a single or double gate system is activated while the gate(s) are opening, the operator of the obstructed gate will stop. The second gate in a double swing system will continue to open. The stopped gate can be immediately operated using the remote control or gate release pushbutton provided that the obstruction has been removed. The gate will close. (refer point regarding multiple collision below)

In the case where the gate(s) are closing, both gates will re-open if the anti-crushing mechanism is activated, regardless of which gate is obstructed. As per the above, when activating the system again, both gates will close.

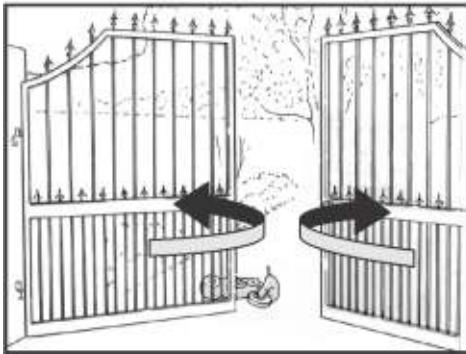

Gate opening onto an obstruction

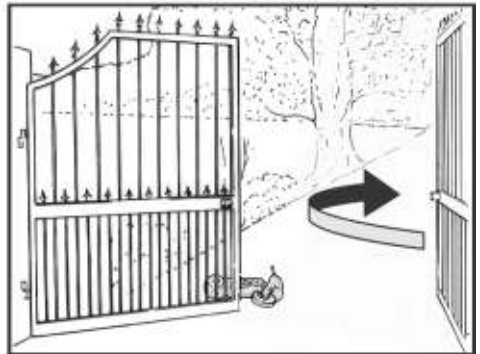

Only the obstructed gate stops.

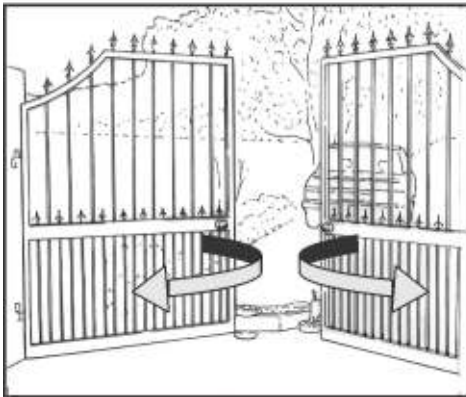

Gates closing onto object.

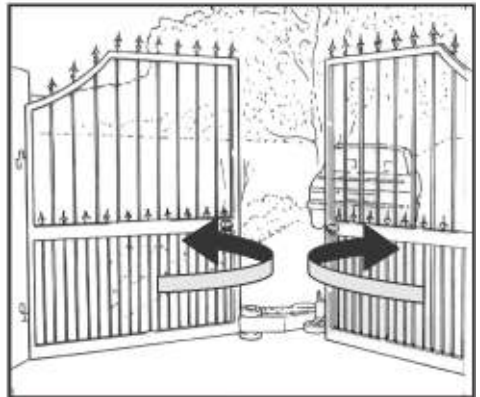

Both gates automatically re-open.

MULTIPLE COLLISION

If the system is obstructed repeatedly 4 times after the initiation of an opening cycle, and before the master motor gets back to its fully closed position, the gate(s) will stop and remain locked in position for 1 minute. After this time the gate can be restarted. This function is a warning to the user that the obstruction must be removed.

The “collision counter” will reset to a count of zero when the master gate is fully closed. The number of collisions that must occur before shutdown is activated is adjustable from 1 to 255.

Automatic Closing

The system has the facility to automatically close the gate after it has been opened. The time that the gate remains open is adjustable from 1 to 255 seconds. The factory default is 15 seconds when the facility is switched ON . By default the auto-close function is off.

AUTO-CLOSE OVERRIDE

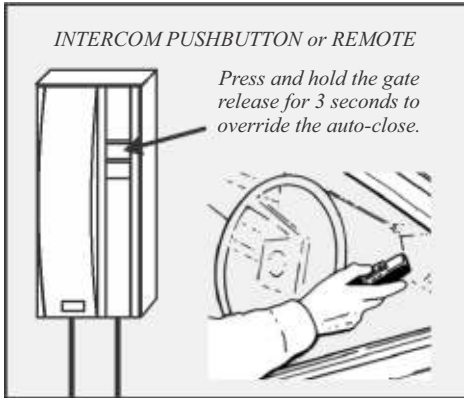

If the auto-close function has been selected it can be conveniently and easily overridden for one cycle. This override feature is activated by holding down the remote control push-button, or intercom gate release button (approximately 3 seconds), when opening the gate, until the gate stops. This confirms that the auto-close has been overridden. On releasing the button the gate will continue to open fully and remain open indefinitely.

Closing the gate by using either the transmitter or intercom gate release button automatically resets the system back to auto-close.

If the status LED (refer to section GATE STATUS indication below) is connected, an additional confirmation of the functioning of the override is provided while the button is held down. The status LED will stop flashing and remain ON when the auto-close has been overridden.

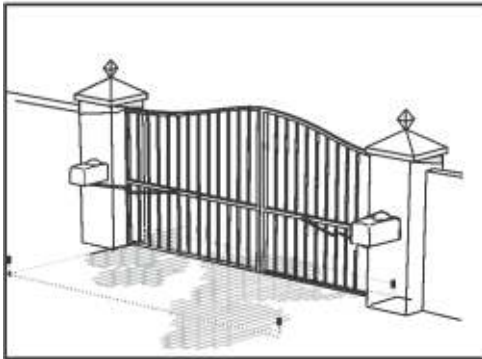

Protection Beam (optional but recommended)

An infra red beam, or underground loop (connected to an inductive loop detector), across the gate entrance may be connected to the controller as an additional safety feature. For optimum protection when using infra red beams, two sets of beams should be used; one on the hingeline of the gates and the second just outside the arc of the gate travel.

When a motor vehicle activates the loop or beam the following occurs:

- If the gate is closing, it will immediately stop and re-open.
- If the gate is open, and the beam is broken, a trigger signal trying to close the gate will be ignored.
- If the AUTO-CLOSE feature is selected, the gate will remain open while the beam is broken or loop is activated. If the beam or loop is cleared the gate will only close again after the normal auto-close time has expired.

Gate Status Indication (optional feature)

The controller can provide visual indication inside the house of the position of the gate and the condition of the battery and power supply. A LED is typically mounted on the intercom inside the house. The different signals of the LED are described below:

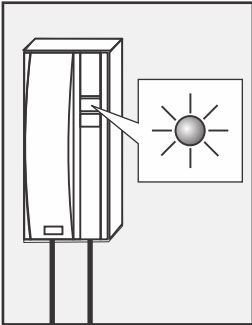

LED STATUS	INDICATION
Slow regular flash	Gate is opening
Fast regular flash	Gate is closing
Off	Gate is closed
On	Gate is open
1 Flash/2 seconds	Courtesy light latched on
2 Flashes/2 seconds	Mains failure
3 Flashes/2 seconds	Battery low
4 Flashes/2 seconds	Collision shutdown

Battery Low Protection

The controller has circuitry that monitors the state of the battery. During a power failure energy is drawn from the battery, but not replaced. To protect the battery from being quickly damaged, the protection circuitry prevents the motors from being run off the battery when the battery voltage drops below 10.6 volts.

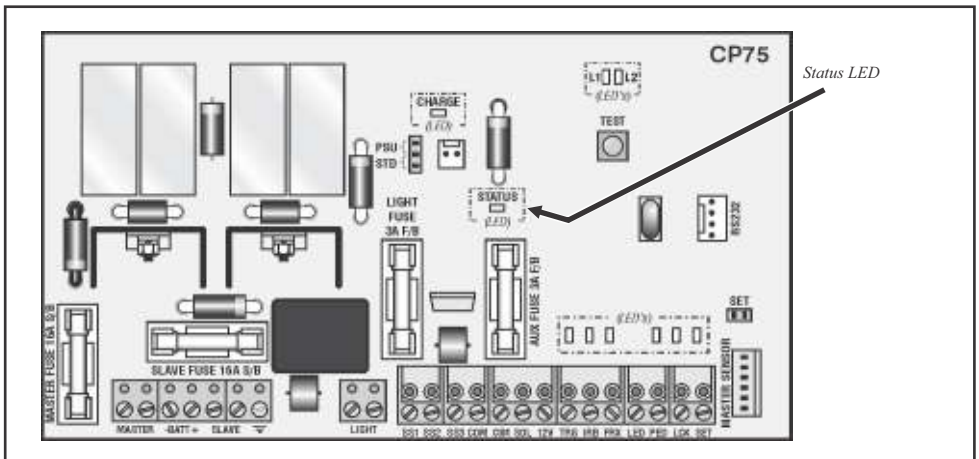

Status LED location on the CP75 Controller Card

Indication that the battery low protection has been triggered is provided by the small gate status LED mounted on the intercom inside the house, which will flash three times every two seconds. The gate system is shut off for at least one minute. After this time the gate system can be reactivated but will shut off immediately again if a battery low condition persists.

CONTACT YOUR LOCAL GATE AUTOMATION SPECIALIST OR CENTURION SYSTEMS IF YOU DISCOVER THAT THE BATT LOW SIGNAL GIVEN BY THE LED INSIDE THE HOUSE CONTINUES TO RE-OCCUR.

If the gate status indicator has not been fitted, there is an equivalent LED mounted on the CP75 marked STATUS, which can be used as a fault finding aid.



NOTE: The controller's battery low protection will ensure that only the motors are prevented from drawing current from the battery. Items such as the radio receiver, Infra red beams etc continue to flatten the battery. An optional battery low cut-out switch (product code CP107) is available which will totally disconnect the battery.

Security (Courtesy) Light Timer (optional feature)

If a 220V power supply is available at the gate, timed security lights can be connected through the controller. Each time the gate is given a signal to operate, the lights will switch on for approximately two minutes and automatically switch off. The time that lights stay on can be programmed from 10 seconds to 42 minutes in increments of 10 seconds.

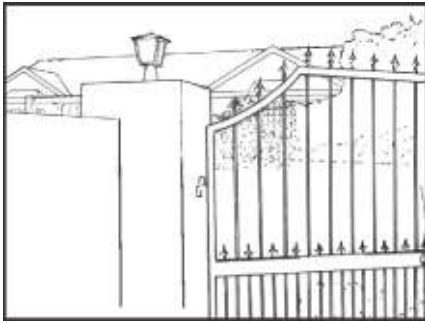

Typical Security or Courtesy Light Installation

If security lights are fitted to the controller, and the pedestrian keyswitch is operated, the security lights will flash twice before the gate opens. (the preflash time is adjustable)

A pushbutton can be connected to the CP75 controller which will allow the pillar/courtesy lights to be switched from inside the house without having to operate the gate.

The pushbutton switches low voltage, and the spare pushbutton provided on many brands of intercom handsets can be conveniently used.

When the pushbutton is pressed momentarily the pillar lights will switch ON for the pillar time period and switch off automatically. If the pushbutton is pressed and held for approximately 4 seconds, the pillar lights will stay on permanently. The lights are switched off by simply pressing the pushbutton again. If the gate status indicator is fitted to the intercom handset, it will flash once every two seconds to indicate that the pillar lights are ON permanently.

Low wattage 12V DC light fittings are also readily available and can be connected to the system, drawing power directly from the battery. Care must be taken to ensure that the power drawn from the system by lights and the motors does not exceed the re-charge rate of the CP84ER5V01 battery charger. A larger charger unit should be fitted to cope with the additional load.

Pre-Flashing

For additional safety, the courtesy light can be programmed to provide an early warning that the gates are about to operate. When the gates are activated the lights will flash for 2 seconds before the gate starts to open or close. The courtesy light timer will still function as normal only in certain modes. (the pre-flash time is fully adjustable in 1 seconds increments. The factory default is 2 seconds). By default pre-flashing is OFF.

Holiday lock out (optional feature)

An ON/OFF keyswitch (or any other convenient apparatus such as a keypad or radio receiver) can be connected to the gate system that will allow the system to be totally immobilised. The keyswitch is mounted with access from the outside of the property. When the keyswitch contact is OFF, the gate system will shut down and it will not be possible to operate the gate. When the keyswitch is ON, the gate

system will operate normally. This is an added security feature should the property be unattended for an extended length of time.

Lightning Protection

The CP75 controller has on-board lightning protection. The protection circuitry is based on a design developed in conjunction with the CSIR. It is however important to realise that the controller's protection only functions correctly if an adequate lightning earth is fitted during installation. Lightning damage is not covered under the normal guarantee of the equipment.

ALTERNATIVE POWER SUPPLY

Solar Panel (Optional)

With the battery driven system, the battery may be charged using a solar panel in place of the conventional charging circuit. A 20 Watt panel will provide on average 10-12 daily operations of an average gate without causing the battery to discharge over a period of time. (The allowable number of operations will be reduced if 12V DC security lights are fitted). It is necessary to have at least a 35A/h deep cycle, low maintenance battery fitted, in order to provide sufficient back-up capacity during days of poor weather

Manual Release

All gate operators have a means of manually operating the gate in the event of a total malfunction of the equipment.

If one is locked outside the property, the padlocks connected to the clevis pin through the gate bracket can be unlocked. This will allow the clevis pin to be removed and the linkage arm to swing away from the gate. This will allow the gate to be opened sufficiently to allow a person to enter.

Once inside the property, to release either operator complete the following procedure:

! **NB:** DO NOT OPEN THE COVERS WHEN EXPOSED TO DIRECT RAIN. ALWAYS SHIELD THE UNIT WITH AN UMBRELLA.

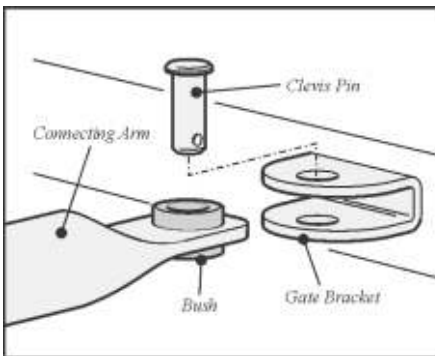

*Unlock the padlock securing the connecting arm.
Remove the clevis pin.*

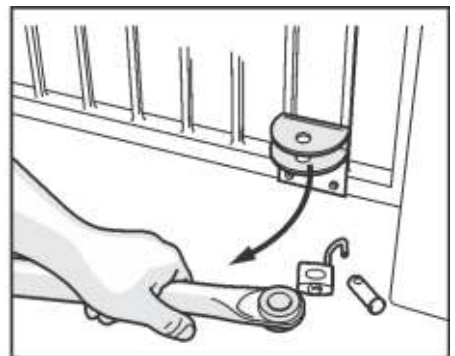

Swing the connecting arm to the side and open the gate.

To release the manual override, proceed as follows:

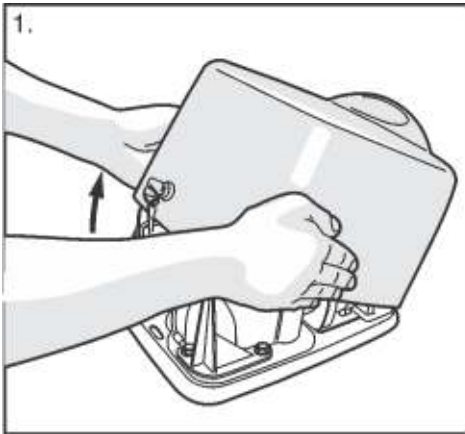

Unlock and remove the operator cover.

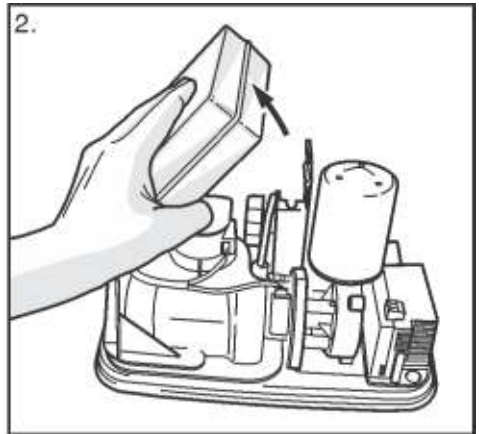

Lift the controller housing fitted to a MASTER motor.
This is not necessary when releasing a SLAVE motor.

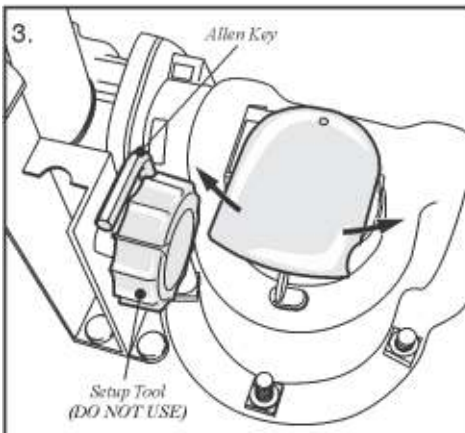

Swing open the manual release dust cover.

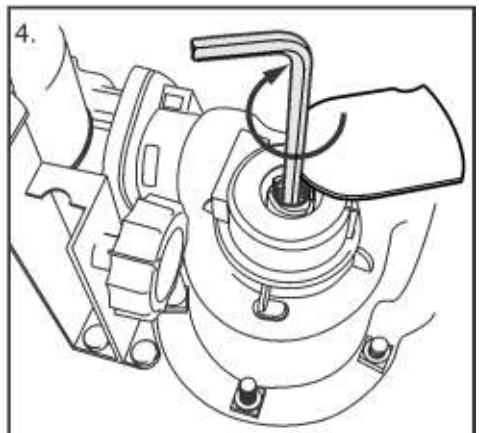

Insert the allen key provided into the manual release mechanism and rotate it clockwise to release the gearbox (approximately 12 turns)

To re-engage the drive (disengage manual override):

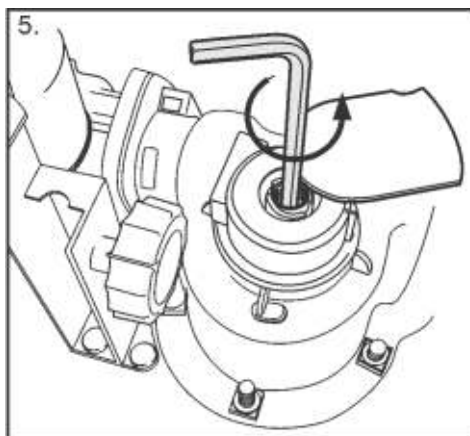

Unscrew the allen key (counter-clockwise) until the top of the screw is flush with the top of the shaft.

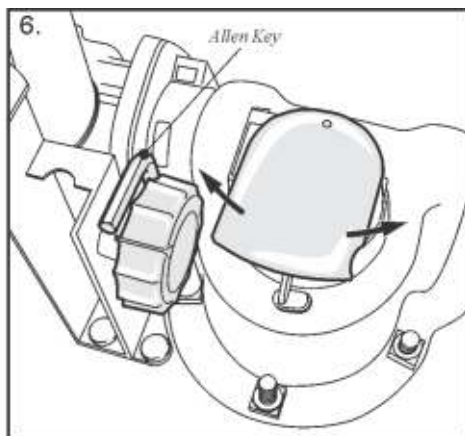

Rotate the dust cover back into position.

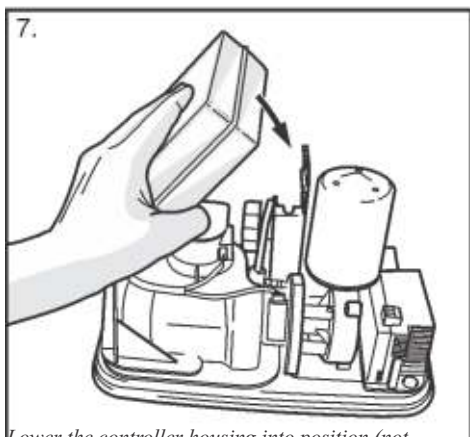

Lower the controller housing into position (not necessary for a SLAVE motor)

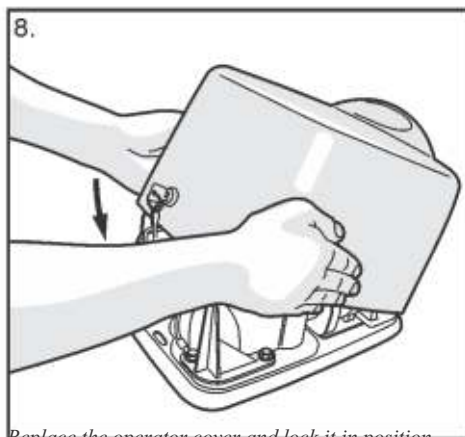

Replace the operator cover and lock it in position.

Basic Maintenance

The CENTURION system is designed to be maintenance free. However, there are some basic checks that should be carried out regularly (every six months) which will increase the long term reliability of the system, and prevent false triggering of the protection systems leading to erratic operation of the gate.



IMPORTANT: ISOLATE MAINS SUPPLY TO SYSTEM BEFORE CLEANING OR WORKING ON THE EQUIPMENT. (NB: The battery driven operators will continue to operate due to the internal battery)

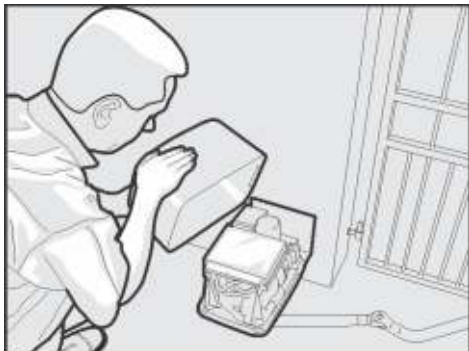

1. Remove all shrubs and vegetation which may interfere with the motors or linkages.
2. Keep the inside of the motors and control housings clear of insects and dirt.



3. Grease the gate hinges to ensure that the gate swings freely.

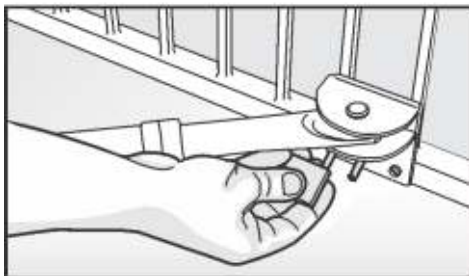

4. Check that the padlocks can be opened. Apply oil or grease to the padlocks, particularly during the rainy seasons.

Battery

All CENTURION domestic systems are fitted with a maintenance free lead acid battery that should provide at least three years of uninterrupted operation.

In the case of a 35A/h battery ensure that the level of liquid (electrolyte level) is correct. (NB: Due to its size the 35A/H will be housed in a separate enclosure).

Check for corrosion of the battery terminals. Clean and apply grease as necessary.

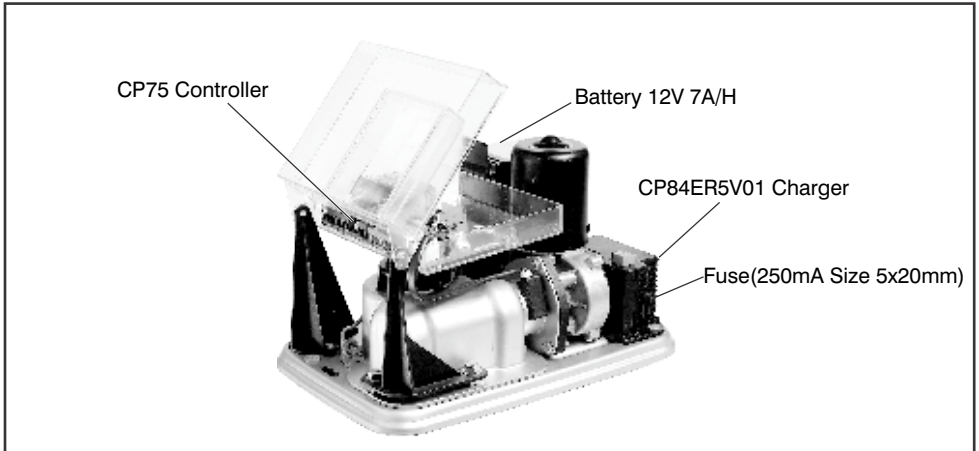

Battery Charger

In domestic applications the R3 and R5 are battery driven. Each system has a built in battery charger which automatically maintains the battery in a fully charged state. The casing may get hot when the charger is in operation. This is quite normal and is no cause for concern.

The small green light (LED) on the CP75 controller marked CHARGER ON should be illuminated at all times. This light indicates that the electricity supply from the charger unit is switched ON. NB: It does not indicate that the charger is charging correctly and therefore it is good practice to have the charging rate of the unit checked from time to time. This is particularly important in areas which are prone to lightning or mains supply surges.

Specification of Charger:

No load charge voltage (measured at battery terminals with battery disconnected) 13.6 to 13.8 volts DC

Charge rate under full load - +/- 1 amp.

Solar Panel

Ensure that the panel is cleaned regularly; excess dirt, dust and leaves collecting on top of the panel will reduce it's efficiency. Cut back any vegetation or trees that are shielding the panel from the sun.

Specifications

SPECIFICATION	R3
Voltage (with CP84ER5V01 power supply unit)	220V AC \pm 10% 50Hz
AC Current draw (with CP84ER5V01 power supply unit)	120mA
DC Current draw (Max)	15A
Maximum solenoid lock current draw	2A
Output shaft rotational speed	3.5 rpm
Maximum output torque	140Nm
Maximum number of operations per day (Average)	100*
Maximum number of continuous operations	20
Typical time to open/close a gate (For standard pedestal in recommended position)	10 seconds
No. of operations on a 7A/H battery (should the mains power fail)	\pm 20
Limit switches	Sealed optical counter with origin switch
Collision sensitivity	Electronic adjustable
Temperature range	-20 to +50°C
Housing protection	IP55
Control card (single or double motor)	CP75
Corrosion protection (baseplate and arms)	Zinc electro galvanising

Maximum gate length & mass:

Gate Length:	1,5m	2,0m	2,5m#	3,0m#	3,5m#
Max. Allowable Leaf Mass:	1000kg	550kg	350kg	250kg	180kg

Max. wind speeds for which the operator will open the gate[†]:

For a 1.8m high gate, 25% coverage:	110km/h	82km/h	66km/h	55km/h	47km/h
For a 1.8m high gate, 100% coverage:	55km/h	41km/h	33km/h	27km/h	23km/h

*Subject to system power supply. Standard battery driven system with 7A/H battery is limited to 20 operations per day.

For pedestal mount installations where the gate exceeds 3m, and wall mount installations where the gate exceeds 2,5m, it is recommended that an electric lock be fitted.

† This applies only to STANDARD pedestal mount installations installed according to the RECOMMENDED positions.

Troubleshooting Guide

This is a basic checklist for your gate automation system. Should you experience a fault with the system, see if the symptom corresponds to any given in the list below. For each symptom listed, the probable cause and action to be taken is given. In the event of the symptom not being listed, consult your installer for assistance.

CAUTION PRIOR TO WORKING INSIDE THE CONTROL CARD ENCLOSURE, ENSURE THAT THE MAINS SUPPLY TO THE SYSTEM HAS BEEN ISOLATED.

NB: As this product is used outside of the control of the manufacturer, CENTURION SYSTEMS (PTY) LTD, it cannot be held responsible for consequential damage as a result of the end user attempting to maintain the unit without the assistance of a qualified installer.

SYMPTOM	CAUSE	ACTION
<ul style="list-style-type: none"> Gate does not open or close fully or gate moves a short distance and stops. 	<ul style="list-style-type: none"> There is an object obstructing the movement of the gate. Anti-crushing device setting is too sensitive Position control system is malfunctioning. Battery voltage is low and the battery protection is being activated. 	<ul style="list-style-type: none"> INDICATION: STATUS LED will be flashing 4 times per 2 seconds. Clear any obstructions from the gate. Unhook the gate from the mechanical linkage and check that the motor operates correctly. Consult your installer should there still be a problem. Check that the sensor mounted adjacent the geared DC motor is clipped into position. Check both MASTER and SLAVE motors where applicable. INDICATION: STATUS LED will be flashing 3 times per 2 seconds. Check that the battery is charging. Check that the mains supply is connected and switched on. Touch the side of the charger unit, it should be hot if the battery is charging. Check battery connections are tight and that there is no

SYMPTOM	CAUSE	ACTION
		corrosion. <ul style="list-style-type: none"> • When was the battery last changed? †
† The life span of the 7A/H maintenance free battery supplied with the system is typically up to three years.		
<ul style="list-style-type: none"> • Gate does not operate but the relays on the controller "click" momentarily. 	<ul style="list-style-type: none"> • Motor fuse blown on the control card. • Battery voltage is low. • Gate lock not releasing (applies to typically single gate installations where a solenoid or magnetic lock has been fitted). 	<ul style="list-style-type: none"> • Replace blown fuses R3-8Amp slow blow. Size 5x20mm • Make sure that the motor fuse holders are making good contact. • See action earlier in this troubleshooting guide for <i>battery voltage is low and the battery low protection is being activated.</i> • Solenoid lock: check that the lock is trying to release. it will make a distinctive "click" sound when energised. Then check that the lock is not being mechanically held due to misalignment, dirt etc. • Magnetic lock: Pull on the lock when activating the gate to release and feel whenever the lock is releasing. Try disconnecting the lock (remove the wire from terminal 13) • Consult your installer if the problem persists.
<ul style="list-style-type: none"> • Gate does not operate and there is no reaction from the motor relays either. Only the radio receiver relay "clicks" when the system is activated. 	<ul style="list-style-type: none"> • An input is latching up the controller. 	<ul style="list-style-type: none"> • Check that both the GREEN IRB (infra red beam) and LCK (holiday lockout) LED's on the CP75 controller are ON. • Check that the other RED

SYMPTOM	CAUSE	ACTION
		<p>input LED's are OFF. They must only light up when the corresponding input is activated.</p> <ul style="list-style-type: none"> • Try operating the system using the TEST pushbutton on the control card. • Consult your installer if the problem persists
<ul style="list-style-type: none"> • Gate does not auto-close. 	<ul style="list-style-type: none"> • Infra red beam (if fitted) is faulty. • Check that the auto-close override facility is not being operated. 	<ul style="list-style-type: none"> • Check that the GREEN LED adjacent the IRB input is ON • When the IRB input is ON • Then the infra red beam is clear. • Check that beam is correctly aligned. It should be possible to hear the relay "click" as the beam is broken and cleared. • Ensure that nobody is mistakenly pressing and holding down the gate release pushbutton on either the remote or intercom for too long when activating the unit. Refer to section <i>Auto-close override</i>.
<ul style="list-style-type: none"> • Gate starts closing but stops and re-opens. 	<ul style="list-style-type: none"> • Intermittent operation of infra red beam if fitted. • Anti-crushing device is set too sensitively. 	<ul style="list-style-type: none"> • Check the GREEN IRB LED on the controller. It must remain ON if the beam is clear. • Consult your installer if the problem persists. • Unhook the gate from the mechanical linkage and check that the operator then drives fully closed. Consult your installer if the problem persists.
<ul style="list-style-type: none"> • Operator drives too far and does not stop in the correct open and closed positions. 	<ul style="list-style-type: none"> • Origin system not functioning correctly. 	<ul style="list-style-type: none"> • Check that the origin sensor which is mounted on the black plastic housing which covers the manual override, is properly clipped in.

SYMPTOM	CAUSE	ACTION
	<ul style="list-style-type: none"> • Origin position has been shifted. 	<p>Consult your installer if the problem persists.</p> <ul style="list-style-type: none"> • Make sure that nobody has accidentally used the origin adjustment tool to release the manual override. Consult your installer should this be suspected.
<ul style="list-style-type: none"> • Gate opens on its own. 	<ul style="list-style-type: none"> • Permanent input on one of the trigger lines to the controller. • Faulty trigger line cables. 	<ul style="list-style-type: none"> • Check that the RED LED's adjacent each trigger input on the controller (TRG, FRX, PED) are OFF and only switch ON when that input is activated. • Consult your installer.
<ul style="list-style-type: none"> • Radio transmitter has poor range. 	<ul style="list-style-type: none"> • Transmitter battery flat. • Radio receiver cannot receive transmitter signal properly. 	<ul style="list-style-type: none"> • Check that the fault only occurs with one of the transmitters. Replace the battery. • Receiver must be mounted in an elevated position, housed in a weatherproof, non ferrous enclosure. • Make sure that the aerial is straight. • Consult your installer.
<ul style="list-style-type: none"> • Master gate opens to pedestrian and closes. 	<ul style="list-style-type: none"> • Key-switch used for activating pedestrian facility is faulty - where applicable. 	<ul style="list-style-type: none"> • Check for corrosion of the wire terminations behind the key-switch. Consult your installer should the problem persist.
<ul style="list-style-type: none"> • Courtesy light does not operate. 	<ul style="list-style-type: none"> • Light fuse blown. 	<ul style="list-style-type: none"> • Replace fuse - 220V 3A fast blow. Size 5x20mm. <p>CAUTION - 220V, make sure supply to system is isolated</p> <ul style="list-style-type: none"> • Check that the lamp load does not exceed 500W. • Check the bulb and replace if necessary. Make sure that the bulb is making good electrical contact in its holder. • Consult your installer should the problem persist.

Product Guarantee

All CENTURION products are manufactured with extreme care, thoroughly inspected and tested. They are guaranteed for a period of 12 months, provided that proof of purchase documentation is submitted with any claim.

The guarantee only covers repair, components and labour, provided that the equipment is returned to our workshop.

This warrantee will not apply to any equipment which:

- (A) Has been subject to misuse or which has been used for any purpose other than designed for by the manufacturers.
- (B) Has been repaired by any workshop and/or person not previously authorised by CENTURION SYSTEMS.
- (C) Has been repaired with components not previously tested, passed or authorised by CENTURION SYSTEMS.



**Sharecall 0860-CENTURION (0860 236 887)
Head Office: +27 11 699 2400**

**Sharecall Technical Support 0861 003 123 or
+27 11 699 2481
from 07h00 to 18h00 (GMT+2)**

(Sharecall numbers applicable when dialed from within South Africa only)



0.07.A.0100_22072013

www.centsys.com