

SMARTGUARDair Operating
instructions



CENTURION



SMART **GUARD**[™]
air

**HIGH SECURITY
KEYLESS ACCESS
CONTROL**

Contents



How to use this Guide	page 1
General description	page 2
General use	page 4
Powering up	page 5
Glossary	page 6
KwikLearn	page 7
KwikPair	page 9
Technical specifications	page 10
Changing the Master Code	page 11
Adding a new user	page 12
Deleting a user	page 14
Deleting all users	page 16
Pairing	page 17
Setting the anti-hack parameters	page 19
Setting the Key Wipeout time	page 21
Setting the security parameters	page 24
Alarms	page 28
Backing up the unit	page 29
Restoring the unit	page 30
Defaulting the unit	page 31
• Defaulting the Master Code	page 31
• Defaulting the System Parameters	page 31
Battery low indication	page 33
Typical mounting instructions	page 34
Fitting the optional anti-tamper switch	page 35
External 12V DC power	page 36
Typical applications	page 37
Installation information	page 38

How to use this Guide >>

The procedures in this Guide require the user to perform certain sequential actions on the **SMARTGUARDair** keypad. To assist you, the combined state of the three LED indicators on the keypad correspond with particular steps within a procedure. When carrying out the procedures, please be aware of the following:

The factory default Master Code **1 2 3 4** is used throughout this Guide as an example only. Refer to page 6 for instructions on how to change the Master Code.

- 1** Indicates a particular key to be pressed on the keypad by the user
-  Indicates a lit LED
- [] Indicates optional entries. If no variable is entered, the system will use the default for the particular function, where applicable

General description >>

The CENTURION **SMARTGUARDair** is a durable, high quality keypad designed to provide secure access control to restricted areas. The weatherproof unit is wireless, and is powered by two AA alkaline (penlight) batteries. When any key is pressed, a backlight illuminates the keypad for ease of use in low-light conditions.

Access is granted by the keying in of a valid access code. The access code can vary from one to ten digits. Up to one thousand different access codes can be stored within the unit's non-volatile memory.

Each access code is stored in a location of the memory, referred to as an 'address'.

New codes can be added and existing codes can be deleted as required.

'Token codes' can be added, allowing only a preset number of activations, after which the code automatically becomes invalid.

Channel 3 is used as the Alarm Channel (refer to page 28) and cannot be changed. If alarm functionality is required, then it is advisable that Channel 3 is not assigned to any other function.

Each code can activate one of fifteen channels built into the **SMARTGUARDair**. A channel is very much the same as a remote control button. Each channel can activate an external CENTURION rolling code-compatible receiver, either stand-alone, single channel, multichannel or integrated into products such as the D5-Evo, D10, VECTOR2, etc.

An Anti-hack feature can be enabled, causing the unit to shut down after a pre-selected number of incorrect codes have been entered. The unit will then reset after a pre-selected time. A telltale LED will indicate that the Anti-hack feature has been triggered.

Once programmed, the system can be backed up onto the optional Backup Memory Module (Code PCA12201V1.0). This allows the system to be easily restored if required.

An optional independent Anti-tamper Switch can be fitted and wired internally to transmit an alarm signal if the unit has been forced open, or removed from its mountings.

General use >>

After a user has been added to the **SMARTGUARDair's** memory and the keypad has been paired with a compatible rolling code receiver, access is granted by keying in a valid code and confirming the entry with the **#** key.

For example, if the code **2 9 8 5 6** is being used as an access code, the user will enter the digits in sequence and then press **#**. The green LED will illuminate briefly to indicate that a valid access code has been entered. Briefly pressing the **#** key after a code has been entered will cause the **SMARTGUARDair** to transmit a signal for a minimum of 750ms (milliseconds). However, holding down the **#** key will allow for a transmission of up to eight seconds which will accommodate receivers requiring longer transmission times. (This may be referred to as Hash-Hold.)

Powering up >>



In order to preserve battery life, the unit is packed with the link fitted on the 12V side of the power selection pins.

To select batteries as the primary power source, bridge the pin marked 'AA BATT' with the common (centre) pin.

For information on selecting 12V as the primary power source, refer to page 36.

Glossary of terms >>

Access code

The code number the user will enter to gain access. It can range in length from one to ten digits.

Address/User address

The location where the user's code is stored in the keypad memory. It can be any number between 1 and 999. It should be recorded, allowing the user code to be removed from the memory later if necessary.

Master Code

The code number required for programming the keypad. It is stored in user address 0.



The default Master Code of a new unit is 1 2 3 4 .

For security reasons, the installer should change this code at the time of installation.

Although 1234 is the default Master Code, up to ten digits per code may be specified, and is encouraged to improve security.

Refer to page 11 for instructions on how to change the Master Code.

Enter key

In order to gain access, the user code must be followed by the # key. (Refer to General use section on page 4.)



The following KwikLearn procedure and connection diagrams (see pages 35 and 36) will enable you to start using your **SMARTGUARDair** system right away.

Add a new access code at a specified address.

The code will operate Channel 1 only.

		Indicator LEDs			
Enter the following keystrokes:		STANDBY	<input type="radio"/>	<input type="radio"/>	<input checked="" type="radio"/>
1. Enter Program Mode	* Master Code¹ *	<input checked="" type="radio"/>	<input type="radio"/>	<input type="radio"/>	
2. Select KwikLearn	0 #	<input checked="" type="radio"/>	<input checked="" type="radio"/>	<input type="radio"/>	
3. Enter user address	0 #	<input checked="" type="radio"/>	<input checked="" type="radio"/>	<input checked="" type="radio"/>	
4. Enter access code	new access code #	<input type="radio"/>	<input type="radio"/>	<input checked="" type="radio"/>	

¹ Default Master Code=1234



The **SMARTGUARDair** will have to be paired to a valid receiver before a code will be able to activate it. Thus, the KwikLearn procedure will store a new code in the keypad's memory, but the code will still have to be associated with a receiver using either the KwikPair facility described on page 9, or the Pairing procedure on page 17.

Example:

KwikLearn **access code** **9 3 2 4 5** into **address** **2 5**
Master Code= **1 2 3 4**

Indicator LEDs

Enter the following keystrokes:

STANDBY

- | | | | | |
|-----------------------|---|-------------------------------------|-------------------------------------|-------------------------------------|
| 1. Enter Program Mode | * 1 2 3 4 * | <input checked="" type="checkbox"/> | <input type="checkbox"/> | <input type="checkbox"/> |
| 2. Select KwikLearn | 0 # | <input checked="" type="checkbox"/> | <input checked="" type="checkbox"/> | <input type="checkbox"/> |
| 3. Enter user address | 2 5 # | <input checked="" type="checkbox"/> | <input checked="" type="checkbox"/> | <input checked="" type="checkbox"/> |
| 4. Enter access code | 9 3 2 4 5 # | <input type="checkbox"/> | <input type="checkbox"/> | <input checked="" type="checkbox"/> |



The **SMARTGUARDair** must now be paired with a CENTURION rolling code radio receiver.

1. Place the receiver into Learn Mode.
2. Enter a valid access code on the **SMARTGUARDair**, followed by #.

The **SMARTGUARDair** will now transmit for a short time, and will pair with the receiver.

Hash-Hold may be used (as described on page 4) to extend the transmission time to suit the learning procedure associated with certain types of receivers.

3. Exit Learn Mode on the receiver
4. Test the system by entering a valid access code, followed by #.

Technical specifications >>

Battery supply voltage	2 x AA Alkaline batteries★ (voltage range: 2.6V - 3.3V)
External power supply	External 12V DC power supply
Wireless range†	30 metres
Operating temperature	-18°C to +55°C
Operating humidity	0 - 90%*‡
Output	14 standard channels + one alarm channel
Housing material	Polycarbonate
Degree of protection	IP55
Battery life	Two to five years*§
Code length	One to ten digits
Memory capacity	1000 unique codes (non-volatile)
Memory retention	>200 years
Token codes	1 - 254 activations

★ Only replace with Alkaline batteries. Other types of batteries (NiMH, Li-Ion, etc.) as well as rechargeable batteries **cannot** be used with this product.

† Specified as Line of Sight (LOS) range

* Non-condensing

§ Subject to usage - refer to table in the Battery Low Indication Section on page 33

Changing the Master Code >>>

The following procedure will enable the user to change the default Master Code **1 2 3 4** or the currently stored Master Code to a new Master Code. The Master Code may also be learned into the system by following the procedure on page 12, 'Adding a New User'.



The Master Code must always be stored at address **0**
The Master Code can be used as a normal access code and can be up to ten digits long

Indicator LEDs

Enter the following keystrokes:

STANDBY

1. Enter Program Mode *** Master Code¹ ***



2. Select KwikLearn **0 #**



3. Enter address **0 #**



4. Enter new code **Master Code #**



¹Default Master Code = **1 2 3 4**

Example: Replace the default Master Code **1 2 3 4** with a new Master Code = **3 7 8 1**

Indicator LEDs

Enter the following keystrokes:

STANDBY

1. Enter Program Mode *** 1 2 3 4 ***



2. Select KwikLearn **0 #**



3. Enter address **0 #**



4. Enter access code **3 7 8 1 #**



Adding a new user >>

The following procedure will add a new access code at a specified location in the **SMARTGUARDair's** memory, referred to as an 'address' and will assign which channel the code must activate and how many accesses are allowed before the code becomes invalid.

		Indicator LEDs		
Enter the following keystrokes:		<input type="radio"/>	<input type="radio"/>	<input checked="" type="radio"/>
1. Enter Program Mode	* Master Code *	<input checked="" type="radio"/>	<input type="radio"/>	<input type="radio"/>
2. Select Add Menu	1 #	<input checked="" type="radio"/>	<input checked="" type="radio"/>	<input type="radio"/>
3. Enter user address	Address #	<input checked="" type="radio"/>	<input checked="" type="radio"/>	<input checked="" type="radio"/>
4. Enter access code	new access code #	<input type="radio"/>	<input checked="" type="radio"/>	<input checked="" type="radio"/>
5. Select channel	Channel #	<input checked="" type="radio"/>	<input checked="" type="radio"/>	<input type="radio"/>
6. Enter access limit	[Accesses] #	<input checked="" type="radio"/>	<input checked="" type="radio"/>	<input type="radio"/>
7. Exit Add Menu	#	<input checked="" type="radio"/>	<input type="radio"/>	<input type="radio"/>
8. Exit Program Mode	#	<input type="radio"/>	<input type="radio"/>	<input checked="" type="radio"/>



- **If unlimited accesses are required, only enter # at Step 6.**

- If no channel is specified, Channel 1 is selected by default

- If the number of accesses is not specified in Step 6, unlimited access is set. Care must be taken to ensure the desired access limit is correctly applied



- Repeat steps 3 - 6 for additional users

- [] denotes optional variable

Example:

Add **access code** **5 2 7** into **address** **1 0**

The code must operate **Channel 2**

Code is valid forever

Master Code= **1 2 3 4**

Indicator LEDs

Enter the following keystrokes:

STANDBY

1. Enter Program Mode	* 1 2 3 4 *	<input checked="" type="radio"/>	<input type="radio"/>	<input type="radio"/>
2. Select Add Menu	1 #	<input checked="" type="radio"/>	<input checked="" type="radio"/>	<input type="radio"/>
3. Enter user address	1 0 #	<input checked="" type="radio"/>	<input checked="" type="radio"/>	<input checked="" type="radio"/>
4. Enter access code	5 2 7 #	<input type="radio"/>	<input checked="" type="radio"/>	<input checked="" type="radio"/>
5. Select channel	2 #	<input checked="" type="radio"/>	<input checked="" type="radio"/>	<input type="radio"/>
6. Enter access limit	#	<input checked="" type="radio"/>	<input checked="" type="radio"/>	<input type="radio"/>
7. Exit Add Menu	#	<input checked="" type="radio"/>	<input type="radio"/>	<input type="radio"/>
8. Exit Program Mode	#	<input type="radio"/>	<input type="radio"/>	<input checked="" type="radio"/>

Deleting a user >>

The following procedure will delete an access code at a specified address.

		Indicator LEDs		
Enter the following keystrokes:	STANDBY	<input type="radio"/>	<input type="radio"/>	<input checked="" type="radio"/>
1. Enter Program Mode	* Master Code *	<input checked="" type="radio"/>	<input type="radio"/>	<input type="radio"/>
2. Select Delete Menu	2 #	<input checked="" type="radio"/>	<input checked="" type="radio"/>	<input type="radio"/>
3. Enter user address	Address #	<input checked="" type="radio"/>	<input checked="" type="radio"/>	<input type="radio"/>
4. Exit Delete Menu	#	<input checked="" type="radio"/>	<input type="radio"/>	<input type="radio"/>
5. Exit Program Mode	#	<input type="radio"/>	<input type="radio"/>	<input checked="" type="radio"/>

Example:

Delete **access code** at **address** **9 9**

Master Code = **1 2 3 4**

		Indicator LEDs		
Enter the following keystrokes:	STANDBY	<input type="radio"/>	<input type="radio"/>	<input checked="" type="radio"/>
1. Enter Program Mode	* 1 2 3 4 *	<input checked="" type="radio"/>	<input type="radio"/>	<input type="radio"/>
2. Select Delete Menu	2 #	<input checked="" type="radio"/>	<input checked="" type="radio"/>	<input type="radio"/>
3. Enter user address	9 9 #	<input checked="" type="radio"/>	<input checked="" type="radio"/>	<input type="radio"/>
4. Exit Delete Menu	#	<input checked="" type="radio"/>	<input type="radio"/>	<input type="radio"/>
5. Exit Program Mode	#	<input type="radio"/>	<input type="radio"/>	<input checked="" type="radio"/>





















Example:

Delete **access codes at multiple addresses**, such as **5 4** and **8 7**.

Master Code= **1 2 3 4**

Indicator LEDs

Enter the following keystrokes:

	STANDBY			
1. Enter Program Mode	* 1 2 3 4 *			
2. Select Delete Menu	2 #			
3. Enter user address	5 4 #			
4. Enter user address	8 7 #			
5. Exit Delete Menu	#			
6. Exit Program Mode	#			

Delete all users >>

It is possible to delete all users stored in the **SMARTGUARDair**'s memory, by entering **0** as the user address. This will cause the Master Code to be reverted back to **1 2 3 4** and erase all user codes programmed into the memory.

Indicator LEDs

Enter the following keystrokes:

STANDBY   

- | | | | | | | |
|-----------------------|----------|--------------------|----------|---|---|---|
| 1. Enter Program Mode | * | Master Code | * |  |  |  |
| 2. Select Delete Menu | 2 | # | |  |  |  |
| 3. Enter user address | 0 | # | |  |  |  |
| 4. Exit Delete Menu | # | | |  |  |  |
| 5. Exit Program Mode | # | | |  |  |  |

Example:

Delete **all access codes**. Master Code = **1 2 3 4**

Indicator LEDs

Enter the following keystrokes:

STANDBY   

- | | | | | | | | | | |
|-----------------------|----------|----------|----------|----------|----------|----------|---|---|---|
| 1. Enter Program Mode | * | 1 | 2 | 3 | 4 | * |  |  |  |
| 2. Select Delete Menu | 2 | # | | | | |  |  |  |
| 3. Enter user address | 0 | # | | | | |  |  |  |
| 4. Exit Delete Menu | # | | | | | |  |  |  |
| 5. Exit Program Mode | # | | | | | |  |  |  |

Pairing >>

A clear distinction must be made between the Pairing Menu and the Adding Menu (refer to page 12).

The Adding Menu will be used whenever a new code is to be added to the **SMARTGUARDair**'s memory. This will in turn create a means of 'unlocking' transmission to a designated receiver; whereby a valid code will have to be entered before the unit will begin transmitting.

The Pairing Menu allows the user to pair the **SMARTGUARDair** to one or more CENTURION rolling code receivers within the specified range of transmission; comparable to learning a remote control into a receiver.

		Indicator LEDs			
Enter the following keystrokes:		STANDBY			
1. Enter Program Mode	* Master Code *				
2. Select Pairing Menu	3 #				
3. Enter channel	Channel #				
4. Enter receiver type*	[0 OR 1] #				
5. Enter transmission time	[0 - 90 seconds] #				
6. Exit Pairing Menu	#				
7. Exit Program Mode	#				

* **0** for NOVA receiver

1 for future CENTURION receiver

Once transmission has ended, repeat Steps 3 and 4 for additional channels.



- The default transmission duration is eight seconds, and will be automatically selected if no other value is specified
- The maximum transmission time is 90 seconds
- If no receiver is specified, NOVA is selected by default
- Additional functionality, such as pulsing or latching outputs is handled by the associated receiver

Example:

Pair **Channel 1** with a **NOVA receiver**, allowing for a transmission duration of ten seconds.

Master Code= **1 2 3 4**

		Indicator LEDs		
Enter the following keystrokes:	STANDBY			
1. Enter Program Mode	* 1 2 3 4 *			
2. Select Pairing Menu	3 #			
3. Enter channel	1 #			
4. Enter receiver type	0 #			
5. Enter transmission time	1 0 #			
6. Exit Pairing Menu	#			
7. Exit Program Mode	#			

Setting the anti-hack parameters >>

The following procedure sets the number of consecutive wrong access codes that the **SMARTGUARDair** will accept before becoming inactive, as well as the time for which it will remain inactive.

The Factory Default for wrong access codes is three, while the default reset time is 60 seconds.

		Indicator LEDs		
Enter the following keystrokes:	STANDBY	<input type="radio"/>	<input type="radio"/>	<input checked="" type="radio"/>
1. Enter Program Mode	* Master Code *	<input checked="" type="radio"/>	<input type="radio"/>	<input type="radio"/>
2. Select Lockout Menu	4 #	<input checked="" type="radio"/>	<input checked="" type="radio"/>	<input type="radio"/>
3. Enter number of codes	Wrong codes #	<input checked="" type="radio"/>	<input checked="" type="radio"/>	<input checked="" type="radio"/>
4. Enter Reset Time	Seconds #	<input checked="" type="radio"/>	<input type="radio"/>	<input type="radio"/>
5. Exit Program Mode	#	<input type="radio"/>	<input type="radio"/>	<input checked="" type="radio"/>

- The unit will revert to normal operation after the specified Reset Time
- The orange LED will flash briefly every four seconds as a telltale that the anti-hack alarm has been invoked
- The telltale LED indication will revert to the normal red LED flashing indicator on correct entry of a code



Example:

Set **Wrong Code Alarm** to activate after five incorrect codes have been entered. The unit must revert to normal operation after 30 seconds.

Master Code=**1 2 3 4**

		Indicator LEDs		
Enter the following keystrokes:	STANDBY	<input type="radio"/>	<input type="radio"/>	<input checked="" type="radio"/>
1. Enter Program Mode	* 1 2 3 4 *	<input checked="" type="radio"/>	<input type="radio"/>	<input type="radio"/>
2. Select Lockout Menu	4 #	<input checked="" type="radio"/>	<input checked="" type="radio"/>	<input type="radio"/>
3. Enter number of codes	5 #	<input checked="" type="radio"/>	<input checked="" type="radio"/>	<input checked="" type="radio"/>
4. Enter Reset Time	3 0 #	<input checked="" type="radio"/>	<input type="radio"/>	<input type="radio"/>
5. Exit Program Mode	#	<input type="radio"/>	<input type="radio"/>	<input checked="" type="radio"/>

Setting the Key Wipeout time >>>

The following procedure sets the number of seconds for which keystrokes remain valid. This ensures that if a partial code has been entered, it is wiped out of the keypad buffer after a preset time, and must be re-entered in its entirety. The Key Wipeout time may be specified from 0 to 255 seconds.

The value is interpreted as follows:

- **0** - Key Wipeout is disabled
- **1- 255** - Key Wipeout occurs after the specified number of seconds. The keypad backlight generally mirrors the Key Wipeout setting.













The following rules apply to the Key Wipeout time and the backlight time:

- **If the device is battery powered:**
 - The Key Wipeout time never exceeds 15 seconds; irrespective of the time the user has set as the Key Wipeout time
 - The backlight mirrors the Key Wipeout time exactly
- **If the device is externally powered:**
 - The Key Wipeout time is not restricted in any way
 - The backlight remains on indefinitely; irrespective of the Key Wipeout time setting

Indicator LEDs

Enter the following keystrokes:

STANDBY   

1. Enter Program Mode * **Master Code** *   
2. Select Key Wipeout Menu **5 #**   
3. Enter Key Wipeout Time [**Seconds**] **#**   
4. Exit Program Mode **#**   



- If the Key Wipeout time is set to **0**, Key Wipeout will be disabled (only applicable to externally-powered devices)



Disabling the Key Wipeout time will:

- Compromise the security of the system
- Cause a code entry to be incorrectly recognised as a wrong code if an incomplete code was previously entered

Example:

Set the **Key Wipeout time** to **15 seconds**.

Master Code= **1 2 3 4**

Indicator LEDs

Enter the following keystrokes:

STANDBY

1. Enter Program Mode *** 1 2 3 4 ***

2. Select Key Wipeout Menu **5 #**

3. Enter Key Wipeout Time **1 5 #**

4. Exit Program Mode **#**

Example:

Disable Key Wipeout time.

Master Code= **1 2 3 4**

Indicator LEDs

Enter the following keystrokes:

STANDBY

1. Enter Program Mode *** 1 2 3 4 ***

2. Select Key Wipeout Menu **5 #**

3. Enter Key Wipeout Time **0 #**

4. Exit Program Mode **#**

Setting the security parameters >>

The following procedure sets the conditions under which the Alarm channel (**Channel 3**) will activate. This also sets the Anti-default and Keypad Alarm Tone Mute features.

The following alarm conditions can be set:

Duress (Code + one)(Default=off)

Adding one to the last digit of an access code activates the unit as normal, but also activates the alarm channel. This is used if entering under duress.

E.g. If the access code is **1 2 3 4** entering **1 2 3 5** gives access, but also activates the alarm.

Important when choosing an access code number



If you intend using the Duress Security Parameter, ensure that no consecutive numbers are assigned as access codes.

Ensure that the desired code has not already been allocated

Panic Alarm (* + #)(Default=off)

Pressing the ***** and **#** keys simultaneously activates the Alarm channel.

Wrong Codes (Default=off)

When the number of wrong codes is exceeded, the Alarm channel is activated.

Anti-default feature (Default=on)

To achieve greater security, this feature prevents the system parameters from being reset by the defaulting features.

The Master Code can still be defaulted to **1 2 3 4** , but doing this will break the pairing between the **SMARTGUARDair** and any paired receivers. This pairing will need to be re-established in order to continue using the system.

Keypad Alarm Tone Mute feature (Default=off)

Establishing this feature turns off the audible feedback when entering a code. This prevents an eavesdropper from determining the number of digits in the code. Tones will still be present in Programming Mode.

		Indicator LEDs		
Enter the following keystrokes:		STANDBY		
1. Enter Program Mode	* Master Code *			
2. Select Security Menu	6 #			
3. Set Duress (Code+1)	0 1 #			
4. Set Panic Alarm (*+#)	0 OR 1 #			
5. Set (Wrong Codes)	0 OR 1 #			
6. Set Anti-default	0 OR 1 #			
7. Set Alarm Tone Mute	0 OR 1 #			
8. Exit Program Mode	#			



• **0 #** turns function off, **1 #** turns function on

Example:

























Enable Duress Alarm on (Code + one). **Clear all other Alarm functions.**

Master Code= **1 2 3 4**

Indicator LEDs

Enter the following keystrokes:



























STANDBY   

1. Enter Program Mode	* 1 2 3 4 *			
2. Select Security Menu	6 #			
3. Set Duress (Code+1)	1 #			
4. Clear Panic Alarm (*+#)	0 #			
5. Clear (Wrong Codes)	0 #			
6. Clear Anti-default	0 #			
7. Clear Alarm Tone Mute	0 #			
8. Exit Program Mode	#			

Example:

Set Alarm on Wrong Codes and **leave all other functions unchanged.**

Master Code= **1 2 3 4**

		Indicator LEDs		
Enter the following keystrokes:				
1. Enter Program Mode	* 1 2 3 4 *			
2. Select Security Menu	6 #			
3. Skip Duress (Code+1)	#			
4. Skip Panic Alarm (*+#)	#			
5. Set (Wrong Codes)	1 #			
6. Skip Anti-default	#			
7. Set Tone Mute	#			
8. Exit Program Mode	#			

Alarms >>

The **SMARTGUARDair** allows four different alarms to be set, each of which will activate Channel 3, the designated Alarm Output Channel.

The four alarms available on the **SMARTGUARDair** are as follows:

- **Duress Alarm** - a **settable** alarm feature, activated by adding one to the last digit of an access code
- **Panic Alarm** - a **settable** alarm feature, activated by pressing the * and # keys simultaneously
- **Multiple Wrong Codes Alarm** - a **settable** alarm feature; it is activated by exceeding the pre-set number of allowable wrong codes
- **Anti-tamper Alarm** - a **non-settable** alarm feature, activated when the anti-tamper input is activated. This alarm is always enabled and it is therefore recommended that Channel 3 be used exclusively as an Alarm Output Channel to ensure greater security

Backing up the unit >>

It is possible to back up all the user access codes as well as the system settings to the optional Backup Memory Module (PCA12201v1.0).

This allows the system to be easily restored in the unlikely event of system failure.

Procedure for backing up the unit:

Remove power. Plug the Backup Memory Module into the socket provided. Reapply power. All three LEDs will now be ON.

Enter * Master Code *, then press 1 on the keypad. The green LED will begin to flash, indicating that the memory is being backed up. When the backup is complete, a beep will be heard, and the green LED will turn off. Remove the Backup Memory Module and keep it in a safe place.



- Backing up to a Backup Memory Module will overwrite any information that was previously contained in that Backup Memory Module

Restoring the unit >>

Restores all the user access codes as well as system settings from the optional Backup Memory Module (PCA12201v1.0).

Procedure for restoring the unit:

Remove power. Plug the Battery Backup Module into the socket provided. Reapply power. All three LEDs will now be ON.

Enter * Master Code *, then press 3 on the keypad. The yellow LED will begin to flash, indicating that the memory is being restored. When the memory has been restored, a beep will be heard, and the yellow LED will turn off.

Remove the Backup Memory Module and keep it in a safe place.



- Restoring from a Backup Memory Module will overwrite any information that was previously contained in the **SMARTGUARDair** unit

Defaulting the unit >>>

Both the Master Code and the system parameters (timers, alarm functions, etc.) can be reset to Factory Defaults. This is useful when the Master Code has been forgotten or the system parameters are in an unknown state.

Defaulting the Master Code:

Remove power. Reapply power while holding the **1** key down for two seconds. A beep will then follow, indicating that the Master Code has been reset to **1 2 3 4**. If the Anti-default feature has been enabled, the pairing between the receiver will be broken during this process.



If the user identifies that the pairing has been broken, it is the user's responsibility to ensure that the keypad has not been tampered with, i.e. that additional codes have not been learned into the system. It is advisable, upon realising that the pairing has been broken, to completely default the keypad and erase the codes memory, or to restore the memory using a Backup Memory Module.

The pairing will have to be re-established before the system becomes functional.

Defaulting the System Parameters:

Remove power. Reapply power while holding the **2** and **3** keys down together for two seconds. A beep will then follow, indicating that the System Parameters have been reset to the Factory Defaults shown on the following page.

Wrong Codes:	Three codes
Wrong Codes Reset:	60 seconds
Key Wipeout timer:	Five seconds
Security Parameters:	Anti-default ON, all others OFF

Defaulting is not possible if the Anti-default feature has been set (see page 24)†.



In this case, if the Master Code has been lost, the Master Code must be defaulted back to **1 2 3 4**, which will break the pairing between the **SMARTGUARDair** and all paired receivers.

This pairing will need to be re-established in order to continue using the system.

† By default, the anti-default parameter is enabled to ensure maximum security of the unit.

Typical mounting instructions: >>>

1. Remove retaining screw cover and screws.
2. Insert screwdriver blade into groove provided between the cover and back panel. Lever screwdriver forward to separate the cover from the back panel.



3. Fix the self-adhesive rubber pads into the recesses provided on the rear panel.
4. Attach the rear pane to the mounting surface/gooseneck with the mounting screws supplied.

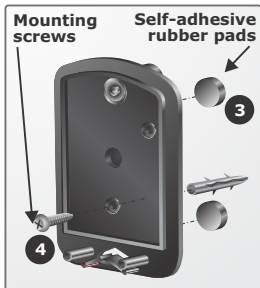

Be sure to seal all the mountings with silicone sealant.



Use only the mounting holes shown. If the other mounting holes are used, the mounting screws will interfere with the batteries.

Battery low indication >>

Once the batteries start to near the end of their service life, the **SMARTGUARDair** will detect the battery low condition and both visible and audible indications will be provided.

The following indications should be noted by the user:

- **Visible:** The red LED will flash rapidly three times, and repeat this action every four seconds
- **Audible:** The tone of the onboard buzzer will be different from its normal pitch during key presses

There will still be a fair amount of usage left before the batteries are completely drained, but it is advisable to replace them as soon as possible to ensure continued operation.

Daily operations	Battery life*
One	12 years
Ten	10 years
50	5 years
100	3 years
200	2 years
500	1 year

* The battery life is characterised but not necessarily tested.

Anti-tamper Switch >>

The Anti-tamper Switch input is a normally-open input. In other words, the input must be tied to common to trigger the Anti-tamper Alarm.

- If the onboard terminals are used to connect the anti-tamper switch, the switch's normally-closed (N/C) and common connections **MUST** be used. Normally-closed (N/C) will be connected to In1 and COM to Neg (-)
- If the anti-tamper switch is to be connected to a third-party alarm system, either normally-closed or normally-open can be used, along with a common connection

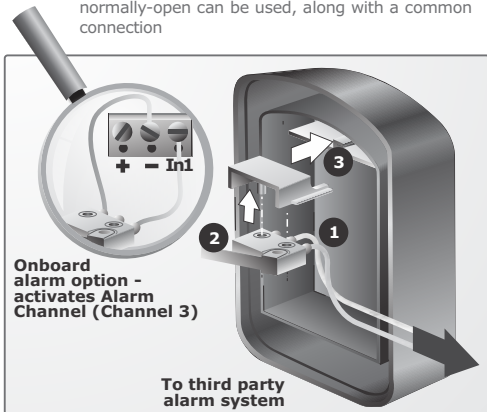

External 12V DC power >>

Refer to this diagram only if an external 12V power source is to be used.❖ Even though an external power supply will provide a more or less unlimited duty cycle, there will be no autonomy whatsoever in the event of a power failure.



❖ **Should an external 12V power supply be used, the power selection link must be moved to bridge the pin marked '12 Volt' with the common (centre) pin.**

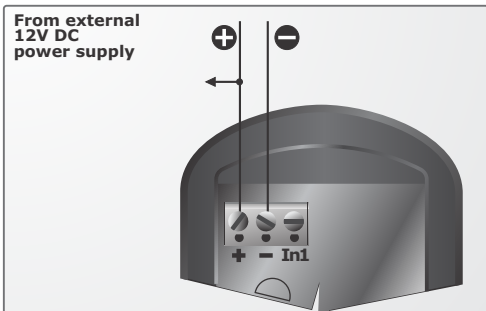

The supply voltage should not exceed 12V DC

Typical applications >>>

Channel 7))



Garage door operator



Channel 3))



Alarm

Channel 1))



Gate operator

IMPORTANT installation information

Complete the installation information below for future reference.



Keep this manual in a safe place.

Master Code

Channel 1 activates

Channel 2 activates

Channel 3*(Alarm Channel) activates

Channel 4 activates

Channel 5 activates

Channel 6 activates

Channel 7 activates

Channel 8 activates

Channel 9 activates

Channel 10 activates

Channel 11 activates

Channel 12 activates

Channel 13 activates

Channel 14 activates

Channel 15 activates

*Channel 3 is always the Alarm Channel, if any of the alarms are used (activated).

Installers information:

Name:

Mobile number:

Email address:

Physical address:

For your convenience you will find an Address Register included in your **SMARTGUARDair** packaging. Use this Address Register to record which addresses have been assigned, their access code and which channel will be activated by that address.



Keep the address register in a safe place!

The supplied Address Register will record the first 512 addresses, from 0 to 512, as well as a space to record your new Master Code. Should you require a second Address Register to record the next 487 addresses, please contact your nearest CENTURION SYSTEMS branch or distributor.



CENTURION

**Sharecall 0860-CENTURION (0860 236 887)
Head Office: +27 11 699 2400**

**Sharecall Technical Support 0861 003 123 or
+27 11 699 2481
from 07h00 to 18h00 (GMT+2)**

(Sharecall numbers applicable when dialed from within South Africa only)



0.07.A.0109_22072013

www.centsys.com