

**CENTURION  
D3, D5, A10  
and FAAC 844  
SLIDING GATE AUTOMATION**

Product Code: CP70SLIDRO

**USER GUIDE**

**Latest Revision: 17.07.2006  
Document Ref.: 1114.D.01.0002\_17**



**CENTURION  
THE AUTOMATIC CHOICE**



## Product Guarantee D3 and D5, version 3

---

The CENTURION D3 and D5 Version 3 sliding gate operators are manufactured with extreme care, thoroughly inspected and tested. The operators are only guaranteed against faulty materials or workmanship for a period of 24 months from the invoice date of the operator or 26 months from the manufacturing date (as shown on the serial number label of the operator), whichever expires first.

The guarantee will cover the repair or replacement at our discretion of such faulty materials or parts free of charge provided that the equipment is returned to our workshop.

The guarantee only applies to the gearbox, motor, controller and other components specific to the operator. Peripheral components such as the charger, battery and other ancillary devices connected to the operator carry the guarantee provided for these components.

This guarantee will not apply to any operator which:

- a. Has been subject to misuse or which has been used for any purpose other than designed for by CENTURION SYSTEMS.
- b. Has not been installed in accordance with the installation instructions provided.
- c. Has damage caused as a result of handling during transit, atmospheric conditions, insect infestation, power surges or other forces outside of our control.
- d. Has been repaired by any workshop and/ or person NOT previously authorized by CENTURION SYSTEMS.
- e. Has been repaired with components not previously tested, passed or authorized by CENTURION SYSTEMS.

## Product Guarantee A10 & FAAC 844

---

All CENTURION products are manufactured with extreme care, thoroughly inspected and tested. The products are only guaranteed against faulty materials or workmanship for a period of 12 months from the invoice date of the product or 14 months from the manufacturing date (as shown on the serial number label of the operator), whichever expires first.

The guarantee will cover the repair or replacement at our discretion of such faulty materials or parts free of charge provided that the equipment is returned to our workshop.

This guarantee will not apply to any equipment which:

- a. Has been subject to misuse or which has been used for any purpose other than designed for by the manufacturers.
- b. Has not been installed in accordance with the installation instructions provided.
- c. Has damage caused as a result of handling during transit, atmospheric conditions, insect infestation, power surges or other forces outside our control.
- d. Has been repaired by any workshop and/ or person NOT previously authorized by CENTURION SYSTEMS.
- e. Has been repaired with components not previously tested, passed or authorized by CENTURION SYSTEMS.

# Company Profile

---

CENTURION SYSTEMS has been manufacturing automatic gate systems since 1987, and is committed to providing reliable, cost effective solutions in the field of access automation.

CENTURION strives to give service and backup second to none. Our engineers are available to give sales support, installation training, and answers to technical or installation problems.

The equipment is installed worldwide and is available through a network of distributors.

CENTURION is an ISO 9001 - 2000 registered company, continually looking at updating its products in line with world trends to ensure that its products will provide customer satisfaction.

Further information is available on our web site [www.centsys.co.za](http://www.centsys.co.za)



© CENTURION SYSTEMS (PTY) LTD 2005

Centurion Systems (Pty) Ltd. reserves the right to make changes to the products described in this manual without notice and without obligation of Centurion Systems (Pty) Ltd. to notify any persons of any such revisions or changes. Additionally, Centurion Systems (Pty) Ltd. makes no representations or warranties with respect to this manual.

No part of this document may be copied, stored in a retrieval system or transmitted in any form or by any means electronic, mechanical, optical or photographic, without the express prior written consent of Centurion Systems (Pty) Ltd.



# Table of Contents

---

INTRODUCTION . . . . .	7
MODELS COVERED. . . . .	7
MAIN FEATURES . . . . .	7
NORMAL OPERATION. . . . .	9
Radio transmitter. . . . .	9
Intercom pushbutton . . . . .	9
Pedestrian keyswitch . . . . .	10
CONTROLLER FEATURES & FUNCTIONS . . . . .	11
Introduction. . . . .	11
Anti-crushing device . . . . .	11
Automatic alignment . . . . .	12
Automatic closing . . . . .	12
Auto-close override . . . . .	12
Mains failure detection . . . . .	13
Battery low protection . . . . .	13
Thermal overload . . . . .	14
Origin sensor fail . . . . .	14
Lightning protection . . . . .	14
ANCILLARY EQUIPMENT . . . . .	14
Protection beam . . . . .	14
Holiday lockout . . . . .	15
Courtesy light timer . . . . .	15
Pre-flashing . . . . .	15
Gate status indication . . . . .	16
Solar panel . . . . .	17
DC converter module . . . . .	17

SPECIAL FUNCTIONS . . . . . 19

Reversing mode . . . . . 19

Condominium . . . . . 19

Passive infra red auto-close (PIRAC) . . . . . 19

MANUAL RELEASE . . . . . 20

Re-engaging the manual release. . . . . 21

BASIC MAINTENANCE . . . . . 21

General. . . . . 21

Battery . . . . . 22

Gearbox oil level . . . . . 22

Power supply . . . . . 22

A10 Inverter module . . . . . 23

SPECIFICATIONS . . . . . 24

D3/D5/ operator . . . . . 24

A10 operator . . . . . 25

A10 DC converter . . . . . 25

FAAC 844 . . . . . 26

OPTIONAL EXTRAS . . . . . 27

DECLARATION OF CONFORMITY . . . . . 28

COMMISSIONING CHECK SHEET . . . . . 29 & 30

# Introduction

---

This guide highlights the features and operation of CENTURION SLIDING GATE OPERATORS to ensure that YOU, the user, get the most from your system. Basic maintenance is also described, but in the event of product malfunction, you are advised to contact your installer, or your local Centurion branch (refer to back page).

## Models Covered

---

- CENTURION D3
- CENTURION D5
- CENTURION A10
- FAAC 844 (with Centurion CP81 controller)

## Main Features

---

### D3, D5

A key feature of these products is the chassis/gearbox which is moulded from a high tech engineering polymer. The user benefits from this material in terms of its aesthetics, and corrosion free properties. Due to the self locking action of the internal gearset, the unit is resistant to forced entry.

An optional theft resistant cage is available to give additional peace of mind.

A revolutionary aspect of the CENTURION range of operators is the limit switch mechanism. Mounted internally, and therefore tamper proof, the limit switch monitors the speed and location of the gate, ensuring reliable and safe anti-crushing protection and accurate position control.

Precise control of the gate stopping position is achieved by a high resolution encoder wheel and opto-electronic sensor built into the unit.

The electronic controller has many advanced features including variable sensitivity collision detection, adjustable delay autoclose, pedestrian opening, etc. Advanced lightning protection is built into the controller as standard. On D3/D5 domestic



models a 12V battery is the primary power source thus providing a limited number of operations in the event of a mains power failure. This battery is normally charged by an internal 220V\* charger. For sites where a 220V mains supply is unavailable, an external 220-12V adaptor, or solar panel is optional (see SOLAR PANEL, Page 17 for more details about solar charging)

In multi user applications the D5 operator is available with a transformer rectifier unit (power-pack) which replaces the battery and charger. The power-pack operates directly off a 220V\* mains supply only. Battery back-up is available by simply adding an externally mounted battery.

*\*Alternative voltage ratings are available on request*

## **A10**

Engineered for industrial and high duty sites, the A10 is built around a precision machined, die cast aluminium chassis/gearbox incorporating a self locking gearset. Accordingly the unit is resistant to forced entry.

The integral electronic controller has similar functions to those of the D3/D5 and uses the same technology in terms of origin & encoder signal inputs. Unique to the A10 is the high speed mode, enabling adjustable opening/closing speeds up to 30m/min.

The key to the A10's outstanding torque and duty cycle lies in the 3-phase induction motor and electronic inverter that form the heart of the system. Single-phase 220V AC power is converted into variable frequency 3-phase power, allowing electronically controlled soft starting and stopping of the motor.

An optional DC converter is available, containing 12V batteries and UPS type backup circuits. This enables the A10 to continue operating for a limited period in the event of a power failure. Another option is the anti theft cage, to give additional peace of mind.

“Endurance” & “Heavyweight” derivatives of the A10 are available to suit high duty, and high gate mass sites respectively.

## **FAAC**

All FAAC models feature die cast aluminium gearboxes enclosing a self locking gearset.



The FAAC 844 models employ an inductive proximity limit switch, which has no moving parts, thereby improving reliability. Electronic controllers are integral with all 844 models except the 844 three-phase model, in which case the electronics are housed in a separate wall mounted enclosure.

## Normal Operation

---

The gates can be opened or closed in the following way:

### **RADIO TRANSMITTER**

A handheld radio transmitter, carried in the motor car, sends a coded signal to the receiver mounted in the control enclosure to open or close the gate.

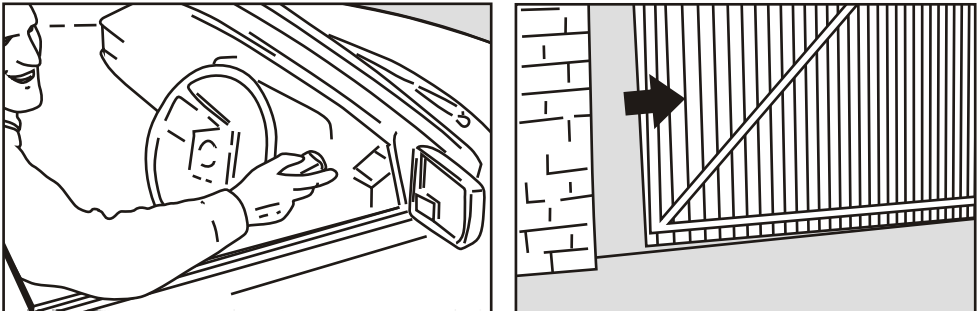

*-Press once for approximately 1 second to initiate gate motion.*

If the transmitter is pressed while the gate is either opening or closing the gate will immediately stop. Pressing the button again will cause the gate to reverse.

If the automatic closing feature (see *Controller Features and Functions*) has been selected and the gate is closing automatically when the transmitter is pressed, the gate will stop and stay in that position. Pressing the button again will cause the gate to reopen. If the gate is opening with the automatic closing facility selected, and the transmitter is then pressed, the gate will stop. The gate will close automatically after the auto-close delay time.

### **INTERCOM PUSH BUTTON:**

Most automatic gate installations are fitted with an intercom which provides for communication between the house and the gate. The intercom handset is usually

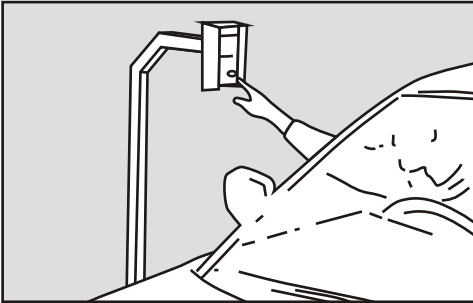

*Visitor outside gate requests entrance.*

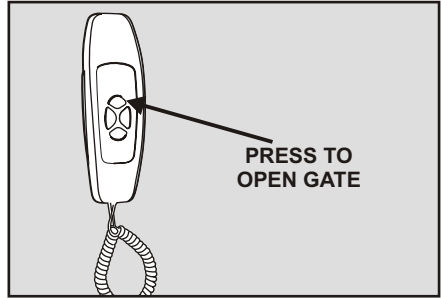

*Gate opened from intercom pushbutton inside house.*

provided with a "Gate" or "Door Release" pushbutton which, when pressed, sends a signal to the gate controller to open the gate.

The sequence of operation of this pushbutton is identical to the radio transmitter described under "Radio Transmitter".

### **PEDESTRIAN KEYSWITCH (OPTIONAL)**

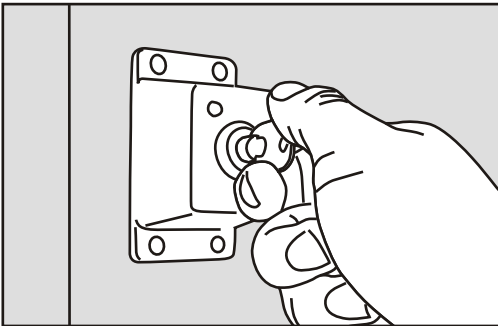

The pedestrian keyswitch is fitted to the gate pillar. It's purpose is to open the gate a limited amount for pedestrians.

- Fit key into keyswitch and turn key clockwise as though starting a motor car.
- Let key spring back to rest position and remove key immediately.

To allow time for removal of the key, there is a 5 second delay before the gate begins to open. If the courtesy light is connected to the control card it will flash five times, indicating that the signal has been accepted.

The gate will open approximately 1 metre and then stop. After 5 seconds the gate will automatically close.

The gate can be held open by keeping the key turned in the keyswitch. As soon as the key is released back to its normal rest position, the gate will close after the 5 second

delay. (The opening distance and the time that the gate remains open can be adjusted to suit. Default values are described above)

If a protection beam has been fitted (refer section “Protection Beam”) and the beam is broken while the gate is closing, the gate will stop. The gate will remain in that position while the beam is broken and only close 5 seconds after the beam has been cleared.

## Controller Features and Functions

### INTRODUCTION

The electronic controller synchronizes the functions of the gate operator. Although the controllers for each operator are marginally different, the functions and safety features which are described below are similar.

### ANTI-CRUSHING DEVICE

#### Gate Closing

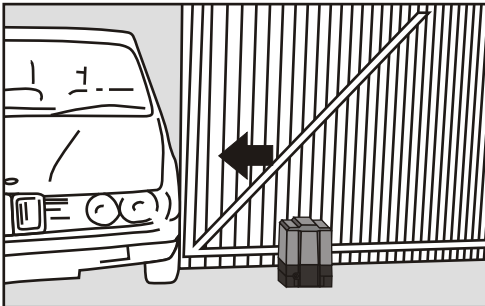

Gate closing into an obstruction

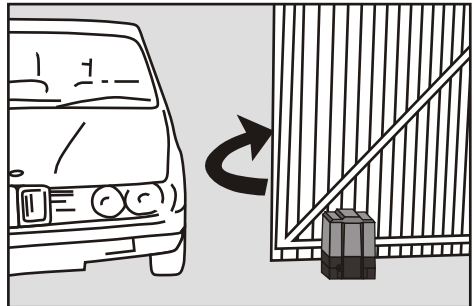

Gate automatically reverses and re-opens

#### Gate Opening

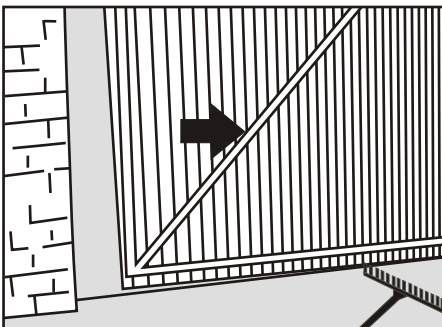

Gate opening

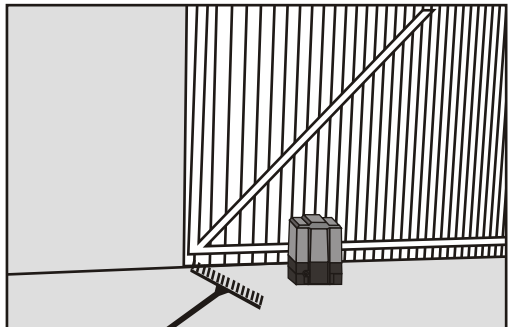

Gate stops on hitting the obstruction

**!** (For CENTURION models only). If the gate is obstructed repeatedly 4 times, either opening or closing, often referred to as multiple collision, the gate will stop and will not respond to trigger inputs for 2 minutes.

After this time the gate will once again respond to command signals. This function is a warning to the user that the obstruction must be removed. (The number of obstructions before the system will shutdown can be adjusted to suit, default is 4).

The FAAC units do not reverse on striking an object when in the closing mode. For both opening and closing modes, the mechanical clutch will start slipping and if no operator input is provided, the motor will automatically cutout after 1 minute.

### **AUTOMATIC ALIGNMENT**

CENTURION and FAAC operators are fitted with a manual override mechanism. This is to allow the gate to be operated in the event of a total malfunction of the equipment. It is also required if the mains power has failed in the case of the 220V operators (A10 and FAAC models).

In the case of the CENTURION operators (D3, D5, A10) when a command signal is given after the gate has been moved manually and then re-engaged, the gate will drive to either it's fully open, or closed, position. Referred to as automatic alignment, the gate can only be stopped, but not reversed until the alignment cycle is complete. The system will then revert to normal operation.

The FAAC units do not have automatic alignment.

### **AUTOMATIC CLOSING (OPTIONAL)**

The system has the facility to automatically close the gate after it has been opened. The default setting is that this facility is disabled. The time that the gate remains open can be adjusted up to 4 minutes where the default is 15 seconds.

### **AUTO-CLOSE OVERRIDE**

The auto-close function can be temporarily overridden by holding down the remote control pushbutton or intercom gate release when opening the gate, until the gate stops. (Default setting is 3 seconds. It can be changed to suit) This confirms that the auto-close has been overridden. On releasing the button the gate will continue to open fully, and remain open as long as required. Closing the gate by using either the transmitter or intercom gate release button resets the system back to auto-close.

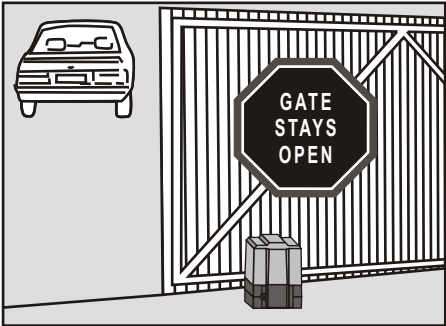
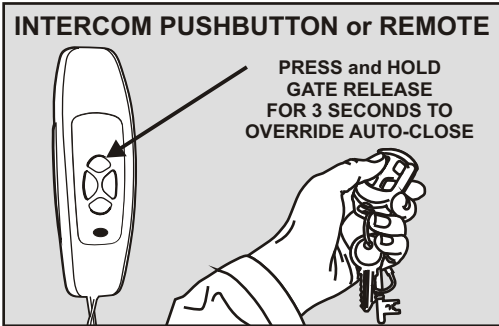

If a gate status indicator (LED) has been fitted inside the house (refer below) an additional confirmation of the functioning of the override is provided. The status LED will stop flashing and remain ON when the auto-close has been overridden.

**MAINS FAILURE DETECTION (D3/D5 ONLY)**

Although these systems will continue to operate in the event of a mains power failure due to the built in battery, it is important to register that there is a problem before the battery is run flat.

The controller (CP80) monitors whether mains voltage (via the charger transformer) is present. If not, the gate status LED, will flash twice every 2 seconds to indicate mains loss.

**BATTERY LOW PROTECTION (D3/D5 ONLY)**

The controller has circuitry that monitors the state of the battery. During a power failure energy is drawn from the battery, but not replaced. To prevent the battery running flat, and being damaged, the protection circuitry shuts off the gate system when the battery voltage drops below 10.6 volts.

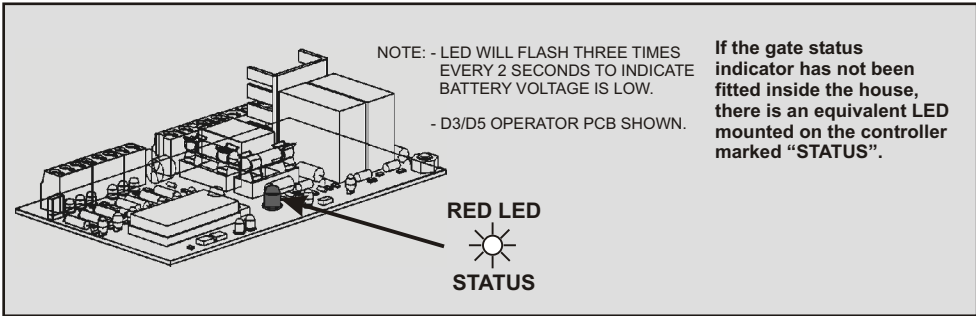



## **THERMAL OVERLOAD (A10 ONLY)**

In the event of the A10 operator being used excessively and the duty cycle rating of the unit exceeded, the unit will shut down due to thermal overload in order to protect the system from abuse.

The unit cannot be re-operated until the unit has cooled. To provide indication to the user that this is the cause of the fault the STATUS LED will flash 2 times every 2 seconds.

## **ORIGIN SENSOR FAIL (A10 ONLY)**

The A10 operator uses an origin switch to ensure it stops in the correct open and closed positions. If this switch fails for any reason, the operator will shut down. To provide indication to the user that there has been an origin sensor failure, the STATUS LED will flash 3 times every 2 seconds.

This condition is treated as serious and the unit cannot be activated again until the gate has been moved manually either fully open or fully closed, ensuring that the gate magnet has passed the sensor. If the sensor registers correctly, the unit will reset, and can be operated again. If the sensor does not re-register, the unit will remain in the locked state.



If the system cannot be reset by following the procedure above, it is a clear indication that the SENSOR is faulty or not switching reliably. It is important that the operation of the SENSOR is checked by a qualified technician.

## **LIGHTNING PROTECTION**

All CENTURION controllers have on board lightning protection. The protection circuitry was designed in conjunction with the CSIR. Provided that the system has been properly earthed the protection will significantly improve the resistance of the system against lightning strikes.

# **Ancillary Equipment**

---

## **PROTECTION BEAM (OPTIONAL, BUT RECOMMENDED)**

An infrared beam, or underground loop, across the gate entrance may be connected to the controller as an additional safety feature. When a motor vehicle activates the loop or beam the following occurs:

- If the gate is closing, it will immediately stop and reopen.
- If the transmitter or intercom gate release pushbutton is pressed while the beam is broken, or the loop activated, the gate will remain open. The auto-close time will restart its countdown.

### **HOLIDAY LOCKOUT (OPTIONAL)**

A keyswitch can be connected to the gate system that will allow the system to be totally immobilised. The keyswitch is mounted with access from the outside of the property. When the keyswitch is OFF, the gate system will shut down and it will not be possible to operate the gate. When the keyswitch is ON, the gate system will operate normally.

This is an added security feature should the property be unattended for an extended length of time.

The holiday lock out facility could also be activated using a keypad, radio receiver with a latching output or an ON/OFF toggle switch.

### **COURTESY LIGHT TIMER (OPTIONAL)**

If a 220V power supply is available at the gate, timed courtesy lights can be connected through the controller. Each time the gate is opened, the lights will switch on for a period of time and switch off. The time can be adjusted up to 40 minutes in 10 second increments.

A courtesy light pushbutton can be mounted inside the house (typically on the intercom) allowing convenient control of the lights. By pressing the pushbutton.

By pressing the courtesy light pushbutton (if fitted), momentarily the light will switch on for the light timer period and automatically switch off. By pressing and holding the pushbutton down for 3 seconds the lights will switch on and remain on. The status LED (if fitted) will flash once every 2 seconds to confirm this. To switch off the lights press the pushbutton momentarily. If courtesy lights are fitted to the controller, and the pedestrian keyswitch is operated, the courtesy lights will flash for 5 seconds before the gate opens. This warns the pedestrian that the gate will open within 5 seconds allowing time to remove the key and stand back from the gate.

### **PRE-FLASHING**

The courtesy light can be programmed to flash for a period of time before the gate

starts to open or close. The courtesy light timer will function as normal. (Preflash time can be adjusted to suit, from 1 to 250 seconds, where the default is 5 seconds). By default pre-flashing is off.

**GATE STATUS INDICATION (OPTIONAL)**

The controller can provide visual indication inside the house of the position of the gate and the condition of the battery and power supply. A LED is typically mounted on the intercom inside the house. The different signals of the LED are shown in the following table:

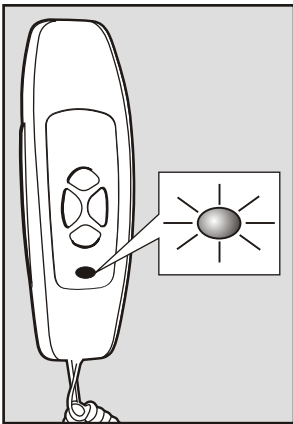

<i>LED STATUS</i>	<i>INDICATION</i>
Slow regular flash	Gate is opening
Quick regular flash	Gate is closing
Off	Gate is closed
On	Gate is open
1 Flash/2 seconds	Courtesy light switched on (see Courtesy Light Timer, page 15)
2 Flashes/2 seconds	Mains failure (D3/D5 only. See Mains Failure Detection, page 13)  Or:  Over temperature (A10 only. See Thermal Overload, page 14)
3 Flashes/2 seconds	Battery low (D3/D5 only. See Battery Low Protection, page 13)  Or:  Missed origin (A10 only. See Origin Sensor Fail, page 14)
4 Flashes/2 seconds	Collision shutdown (Except FAAC units) (See Anti-crushing Device, page 11)



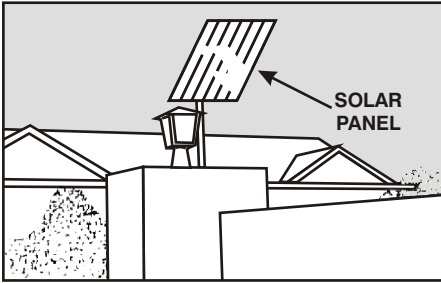

### **SOLAR PANEL (OPTIONAL ON D3/D5 SYSTEMS ONLY)**

The battery of the 12V DC operator may be charged using a solar panel in place of the conventional charging circuit. A 12 Watt panel will provide on average 10 - 12 operations of an average gate without causing the battery to discharge over a

period of time. It is necessary to have at least a 35A/H deep cycle low maintenance battery fitted, in order to provide sufficient backup capacity during days of poor weather. For further details contact your local CENTURION agent.

### **DC CONVERTER MODULE (OPTIONAL FOR A10 ONLY)**

The DC converter module allows the A10 gate operator to function from a 12V battery in the absence of AC mains. The converter module steps up the 12V battery supply to 310V DC. The inverter drive on the A10 operator then switches the high voltage DC supply to run the three phase induction motor.

#### **⚠ WARNING**

**The 310V DC supply is hazardous and potentially lethal. The A10 converter module should be installed and maintained by a qualified installer.**

The following features are of interest to the end-user:

The converter module includes battery protection circuitry. This circuitry prevents the converter module from being damaged in the event of reverse polarity connection. In addition the circuitry automatically disconnects the battery when the battery drops into a low-voltage state. This prevents the converter module from running the battery flat and potentially damaging the battery.

There is a push button on the converter module that manually reconnects the battery in the event of a power failure and low-battery voltage state. Upon activation, and if the battery voltage exceeds the low-voltage parameter, the protection circuitry will automatically keep the battery connected to the converter. If, on the other hand, the battery voltage is below the low-voltage parameter, the protection circuitry will not connect the battery to the converter.

The DC Converter module has three status LED's. These LED's indicate battery status, AC mains status, and lastly the temperature of the converter. The LED's operate in the following manner:

LED	When ON, it indicates:	Logic	When OFF, it indicates:	Logic
<b>Battery status</b>	Battery is fully charged		Voltage low	DC converter will shut down until battery reaches normal operating voltage.
<b>AC Mains</b>	Mains present		Mains failure	DC converter will power A10 until mains restored or battery voltage < threshold
<b>Converter temperature</b>	Overheated	DC converter will shut down until it has cooled to normal operating temperature range.	Converter temperature normal	

The converter module has a current limiting fuse on the high-voltage supply. Caution must be exercised when checking this fuse. The procedure to replace the fuse is outlined below:

1. Disconnect the mains from the entire system. This includes the A10, and the converter module.
2. Disconnect the battery.
3. Disconnect the 6-way header that connects the converter module to the A10. The converter module is now off, and the board is safe to handle.
4. Remove the fuse protection housing (If the housing is still in place).
5. Remove the fuse and replace it with a 5A, 250V, fast-blow fuse. (Dimensions 5x20mm).
6. Reconnect the 6-way header.
7. Reconnect the battery.
8. Reconnect the mains.

Upon reconnecting, if the converter module fails to function correctly in the event of a power failure, refer to an installer or service technician.

# Special Functions

---

## **REVERSING MODE**

Apart from the standard mode of operation as described in the section Normal Operation, the system offers another mode of operation. Referred to as reversing mode, if the transmitter is pressed while the gate is moving, the gate will automatically reverse direction. The gate can never be left in mid position with this mode selected.

Other modes of operation which can be selected and operated using a radio transmitter are CONDOMINIUM and PIRAC, which are described below:

## **CONDOMINIUM**

The system can be programmed for “Condominium” operation. This mode of operation will override the normal mode of operation described under the section “Normal Operation”. This facility is designed for greater safety and security in applications where there will be a number of users, such as the gate at a townhouse estate, factory or office park the “Auto-Close” facility described earlier.

In “Condominium” mode “Auto-close” cannot be overridden. If the remote control or intercom pushbutton is pressed while the gate is open the “Auto-close” will restart its countdown. If the gate is activated while the gate is closing the gate will reopen. The gate cannot be stopped in a midway position and will therefore always close.

A protection beam should be used in conjunction with this facility to prevent the “Auto-close” from closing the gate onto a vehicle passing through.

## **PASSIVE INFRARED AUTO-CLOSE (PIRAC)**

This facility is an extension of the Condominium facility described above. It is designed for applications requiring greater security as the gate closes immediately behind the vehicle or person passing through.

PIRAC will operate only if a protection beam or other type of vehicle detection system (e.g. Inductive loop) has been fitted.

The remote control or intercom pushbutton will only open the gate. As a vehicle drives through the entrance it activates the protection beam and as soon as the vehicle clears the beam the gate will close immediately, even before it is fully open. If the gate reaches the fully open position without the beam being activated the gate will close immediately.



In this mode and for a particular application should the gate start to close too quickly the "Auto-close" facility described earlier can be enabled.

The gate will now remain in the open position until either the "auto-close" has timed out or a vehicle has driven through the entrance in which case the gate will start to close immediately the vehicle has passed.

## Manual Release

All operators are fitted with a manual release mechanism. This is to allow the gate to be operated in the event of a total malfunction of the equipment. It is also required if the mains power has failed in the case of the A10 (without DC converter) and FAAC operators.

**CENTURION D3 & D5**



**Open manual override**

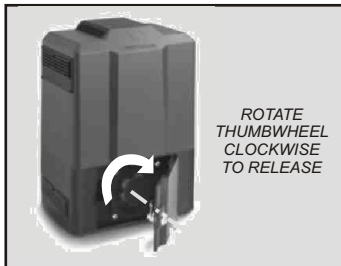

**Rotate thumbwheel clockwise until gate is free to move**

**FAAC 844**

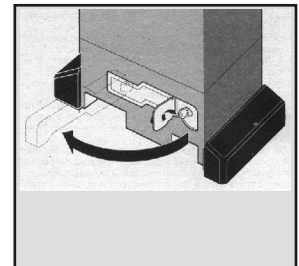

**FAAC844 Manual Release**

**CENTURION D3 & D5**

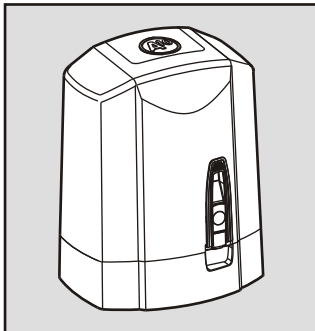

**Manual release handle in closed position.**

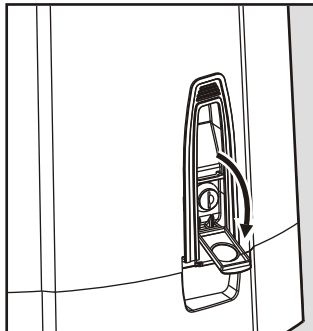

**Open lock cover and insert key. Turn key ¼ turn counter clockwise to unlock.**

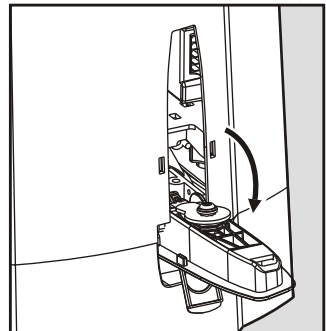

**Pull manual release handle down to disengage manual release**



**RE-ENGAGING THE MANUAL RELEASE (A10 ONLY).** It is strongly recommended that the gate is first pushed to the fully open position, and then to the fully closed position before the release handle is re-engaged. This is to ensure that no untoward behavior occurs due to the system having lost its position information.

## Basic Maintenance

---

CENTURION operators are designed to be maintenance free. However, there are some basic checks that should be carried out regularly, (every six months). These will increase the long term reliability of the system, and obviate false triggering of the protection systems leading to erratic operation of the gate.

**⚠ ISOLATE MAINS SUPPLY TO SYSTEM BEFORE CLEANING OR WORKING ON THE EQUIPMENT.**

### GENERAL

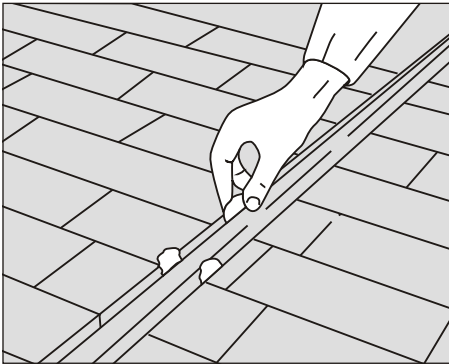

- Keep the track clear of stones, dirt and obstructions.
- Ensure that all rollers are free.
- In manual mode check that the gate runs freely on its rail and does not catch or foul against the walls or pillars.
- Ensure that the gate wheels and guide rollers are rotating freely and are not worn. In high volume applications it will be necessary to replace these components regularly.
- Ensure that the rack is properly secured to the gate and that it does not press down onto the operator pinion at any point along its travel.
- Keep shrubs and vegetation clear of the motor, rack or chain.
- Check that the key still operates the manual override access door or flap. Spray with oil if necessary.
- Keep the inside of the motor housing clear of insects and dust.
- On operators fitted with a cooling fan, check that the air inlet ducts in the cover and the outlet ducts in the gearbox are clear.



## **THE BATTERY (D3/5 OPERATORS ONLY)**

CENTURION systems that are fitted with maintenance free lead acid batteries, should provide at least 3 years of normal service life.

For sites utilizing an external 35A/H battery ensure that the level of liquid (electrolyte level) is correct. Check for corrosion of the battery terminals. Clean and apply copper based grease as necessary.

## **GEARBOX OIL LEVEL (A10 ONLY)**

Check the oil level as described in the section, *Lubrication*, of the Installation Manual. Should the installation manual be unavailable, please refer to the *On Line Manuals* on our website, [www.centsys.co.za](http://www.centsys.co.za). Alternatively, please refer to your CENTURION installer.

## **POWER SUPPLY**

All Centurion/FAAC operators have power supplies separate to the controllers. In the case of product malfunction, the power supply fuses should be checked.

A10 models are supplied with spare fuses housed in the controller card cover. The FAAC 844 houses spare fuses inside the lid.

Be careful to replace A10 fuses with those of the correct rating (see diagram overleaf).

The small green light (LED) on the controller marked - "POWER" - indicates if the card is active. Each power supply has a red light (LED) to indicate mains supply.

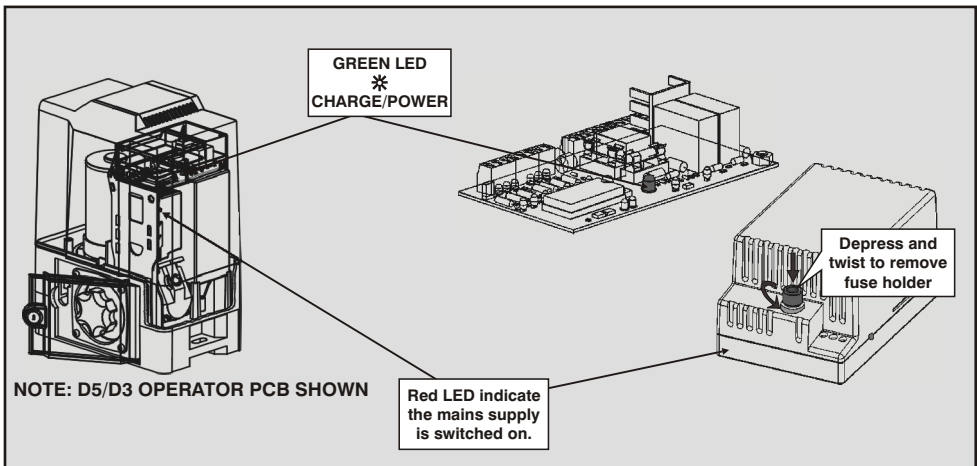

## A10 Inverter Module

### **⚠ WARNING**

The 310V DC supply is hazardous and potentially lethal. The A10 inverter module should be installed and maintained by a qualified installer.

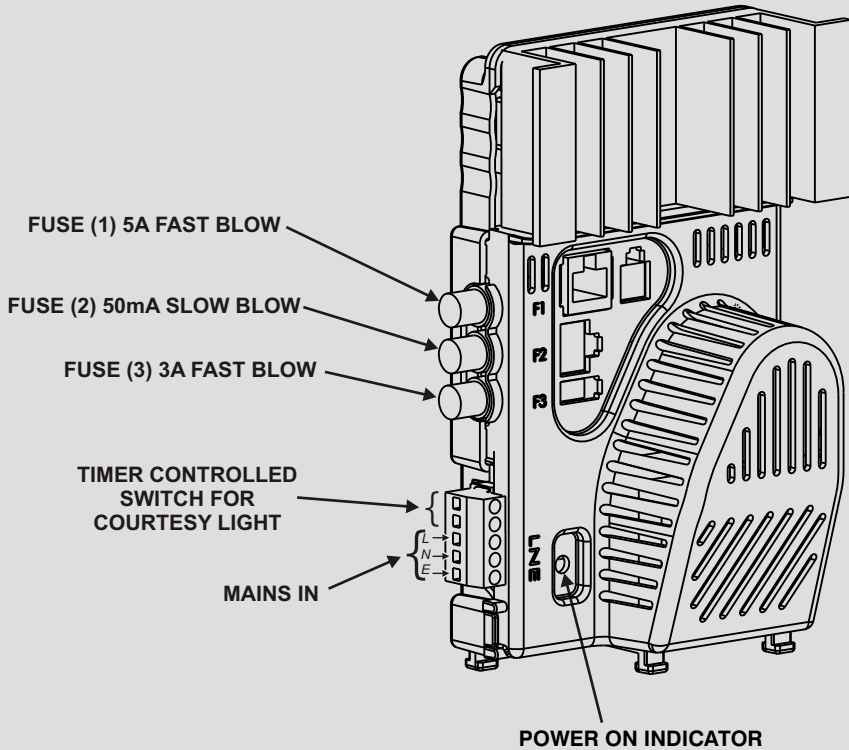



# Specifications

## CENTURION D3 & D5

<b>SPECIFICATIONS</b>	<b>D3</b>	<b>D5</b>
Power supply voltage (Depending on power supply used)	220V AC ± 10% 50Hz 110V AC ± 10% 50Hz 19V AC ± 10% 50Hz	220V AC ± 10% 50Hz 110V AC ± 10% 50Hz 19V AC ± 10% 50Hz
Motor Voltage	12V DC	12V DC
AC Current draw @ 220V	120mA	120mA
DC Current draw (Max)	15A	15A
Output shaft rotational speed	73rpm	91rpm
Rated Gate Speed (With gate pull force <5kg)	16m/min	20m/min
Starting Thrust	35kgF	60kgF
Rated Thrust	12kgF	20kgF
Maximum gate mass	300kg	500kg
Maximum gate length	11m	11m
Maximum number of operations per day (Average) Mains Present:		
Battery driven (1A charger, 7Ah battery)	20	50
Battery driven (2A charger, 7Ah battery)	30	150
Power pack (10A power pack, no battery)	N/A	100
Standby;		
With 7Ah Battery	12	10
With 40Ah Battery	N/A	100
Maximum number of continuous operations per hour Mains Present:		
Battery driven (1A charge, 7Ah battery)	10	10
Battery driven (2A charger, 7Ah battery)	30	30
Power pack (10A power pack, no battery)	N/A	20
Typical time to open/close a 4m gate	17 seconds	13 seconds
End of travel control	Sealed optical counter with origin switch	Sealed optical counter with origin switch
Collision sensitivity	Electronic, adjustable	Electronic, adjustable
Temperature range	-10° to +50°C	-10° to +50°C
Housing protection	IP55	IP55
Control card *	CP80	CP80
Corrosion protection (baseplate)	Zincroshield	Zincroshield
Mass of unit (packed) including 7,5Ah Battery	12kg	13.5kg
* D3 and D5 have different micro-controller versions		



## CENTURION A10

SPECIFICATIONS	A10 BASIC		A10 ENDURANCE		A10 HEAVY WEIGHT
Power Supply	220V +/- 10%, 50Hz - 1 Phase		220V +/- 10%, 50Hz - 1 Phase		220V +/- 10%, 50Hz - 1 Phase
Maximum Absorbed Current	6A		6A		6A
Motor Voltage	220V 3 Phase		220V 3 Phase		220V 3 Phase
Output Pinion	20 Tooth Mod 4		20 Tooth Mod 4		17 Tooth Mod 4
Starting Thrust	40kgF*	30kgF**	40kgF*	30kgF**	47kgF
Rated Thrust	30kgF*	22.5KgF**	30kgF*	22.5KgF**	35kgF
Operating Speed @ Rated Thrust	16m/min	<sup>2</sup> Adj. Up to 30m/min	16m/min	<sup>2</sup> Adj. Up to 30m/min	13.6m/min
Motor Cooling	Direct Drive Fan (1400RPM)		High Efficiency Fan (2300 RPM)		High Efficiency Fan (2300 RPM)
Duty Cycle (continuous) <sup>1</sup>	45%		90%		90%
Duty Cycle (1/2hr endurance) <sup>1</sup>	65%		95%		95%
Ambient Temperature Range	-20°C to +50°C		-20°C to +50°C		-20°C to +50°C
Anti-crushing sensing	Electronic		Electronic		Electronic
Motor Thermal Protection	Electronic		Electronic		Electronic
Maximum Gate length	20m		20m		17m
IP Rating	44		44		44
Optional Battery Back-up	Yes		Yes		Yes
Shipping Mass of Unit	15.5kg		15.7kg		15.6kg
Maximum Gate Mass	1 000kg*	600kg**	1 000kg*	600kg**	2 000kg

(1) At rated thrust and 25°C maximum ambient temperature, unit in full shade.

(2) Refer to RATED THRUST values.

## CENTURION A10 DC CONVERTER

SPECIFICATIONS	DC CONVERTER
Input Voltage	12V DC
Input Current @ Rated Thrust	30A
Rated Output Voltage	310V DC
Battery Charger	1A <sup>4</sup>
Maximum Duty Cycle	20%
Thermal Protection	Electronic
Enclosure	IP65 External Plastic Enclosure
Dimensions	310mm X 240mm X 110mm
Maximum Battery Size	12V 7AH (External 35AH optional)
Open and close cycles <sup>5</sup>	7 - 12 (7AH battery) 40 - 70 (40AH battery)
Shipping Mass	10kg (Inc 7AH Battery)

(4) Upgradable on request.

(5) Dependant on site / environmental conditions.

**FAAC 844**

<b>TECHNICAL DATA</b>	<b>844</b>	<b>8443 PHASE</b>
Power supply	230V ~ (+6% - 10) 50Hz	380V, 3 Phase
Absorbed power	650W	950W
Current draw	3.5A	1.9A
Max. Starting pull	45kgf (Z16) - 35kgf (Z20)	45kgf (Z16)
Temperature range	-20° to 55°C	-20° to 55°C
Motor speed	1400rpm	1400rpm
Reduction ratio	1 ÷ 30	1 ÷ 30
No. Of pinion teeth	Z16 (Z20)	Z16
Rack pitch	4 Module	4 Module
Operating speed	9.5m/min (Z16), 12m/min (Z20)	9.5m/min
Winding thermal protection	120°C	100°C
Duty cycle	40%	60%
Oil quantity	1.8 Litres	1.8 Litres
Type of oil	FAAC XD 220	FAAC XD 220
Housing protection	IP55	IP55
Gear motor weight	14.5kg	16kg
Starting capacitor	35µF	N/A
Clutch	Bidisk in oil bath	Bidisk in oil bath
Control unit	Centurion CP81	Centurion CP81 3 Phase
Limit switch	Inductive	Inductive
Max. Gate mass	(Z16) 1800kg	(Z16) 2200kg
	(Z20) 1000kg	(Z20) 1000kg
Type of cooling	Oil	Oil
Anti-crushing control	Slipping clutch in oil bath	Slipping clutch in oil bath

# Optional Extras

---

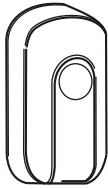

*Beams*

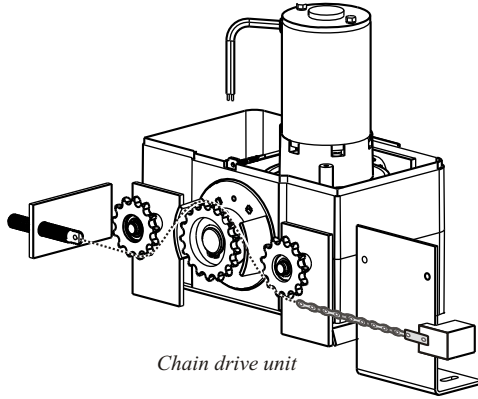
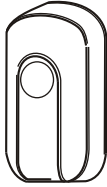

*Chain drive unit*

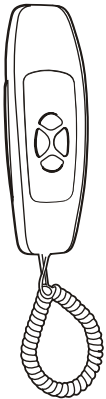

*Intercom*



*Keypad*

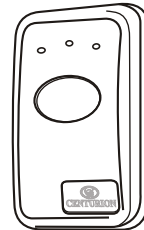

*Prox*

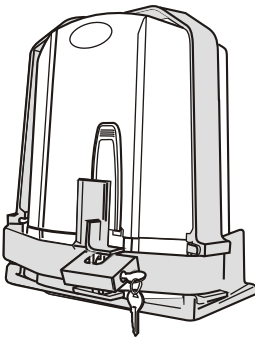

*A10  
Theft resistant cage*

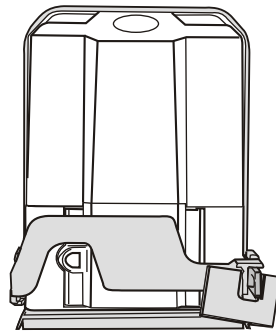

*D3/D5  
Theft resistant cage*



# Declaration of Conformity

---

**Manufacturer:** Centurion Systems (Pty) Ltd  
148 Epsom Avenue  
North Riding  
Gauteng  
South Africa

**Declares that the product:**

Product Name: D3 / D5 Sliding Gate Operator  
Product Options: All variants

**Conforms with the following specifications:**

Safety: IEC 60355-1:1991 & Am1:1994 & Am2:1999  
**For D3:**  
EN 12453:2000 EN 12978:2003 when fitted with CE chip and a P36 Passive Sensitive Edge according to instructions.

Emissions: CISPR 14: 2nd edition 1985  
CISPR 22 CLASS B: RADIATED EMISSIONS - 30MHZ TO 1000MHZ  
CISPR 22 CLASS B: CONDUCTED EMISSIONS - 150MHZ TO 30MHZ

Immunity: IEC 801-2: 2nd edition 1991 - 4kV CD, 8kV AD  
IEC 801-3: 1st edition 1984 - 10V/m  
IEC 801-4: 1st edition 1988 - 1.0kC Power Lines  
IEC 1000-3-2: 1997  
IEC 1000-3-3: 1997  
IEC 1000-4-5: 1997  
IEC 61000-4-2 - ELECTROSTATIC DISCHARGE  
IEC 61000-4-3 - RADIATED IMMUNITY - 80MHZ TO 1000MHZ  
IEC 61000-4-4 - ELECTRICAL FAST TRANSIENTS / BURST  
IEC 61000-4-5 - SURGE IMMUNITY TEST  
IEC 61000-4-6 - CONDUCTED IMMUNITY - 150KHZ TO 80MHZ  
IEC 61000-4-11 - VOLTAGE DIPS AND INTERRUPTION

Supply Information: The product herewith complies with the requirements for the following directives and carries the CE-marking accordingly.  
- the Low Voltage Directive 73/23/EEC  
- the EMC Directive 89/336/EEC (inclusive 93/68/EEC)]  
This product was tested in a typical configuration with simulated gate load.

**Standard to which conformity is declared:**

IEC 60355-1:1991 & Am1: 1994 & Am2: 1999  
IEC 1000-6-3 & IEC 1000-6-1: Generic Emission and Immunity

Signed at North Riding, South Africa on 15 August, 2005

Ian Rozowsky  
Research & Development Director

# General Commissioning Check Sheet

Fill in data for later reference

Model:		Actual	Default	L.E.D. Quick Ref.
All	AUTOCLOSE ON	ON OFF	OFF	2/1 2/2
All	AUTOCLOSE TIME		15 Secs	3/Time
All	MODE	<input type="checkbox"/> Standard <input type="checkbox"/> Condominium <input type="checkbox"/> PIRAC <input type="checkbox"/> Reversing <input type="checkbox"/> PLC (A10 only)	Standard	4/1 4/2 4/3 4/4 4/5
All	PED. AUTOCLOSE TIME		5 Secs	5/Time
All	COURTESY LIGHT TIME		120 Secs	6/Time
All	COLLISION SENSITIVITY	<input type="checkbox"/> High <input type="checkbox"/> Medium <input type="checkbox"/> Low	High	7/1 7/2 7/3
All	AUTOCLOSE OVER-RIDE		3 Secs	8/Time
All	POSITIVE CLOSE MODE	<input type="checkbox"/> YES <input type="checkbox"/> NO	<input type="checkbox"/> NO	9/1 9/2
All	PRE-FLASHING MODE	<input type="checkbox"/> 1 <input type="checkbox"/> 2 <input type="checkbox"/> 3 <input type="checkbox"/> OFF	<input type="checkbox"/> OFF	10/1 10/2 10/3 10/4
	PRE-FLASH TIME		5 Secs	11/Time
	COLLISION COUNT		4	12/Count
D3/D5 A10	CRAWL DISTANCE (1 FLASH = 350mm) COAST MODE (1 FLASH = 10mm) OPENING SPRINT MODE SELECT: <i>Standard speed</i>	<input type="checkbox"/> <input type="checkbox"/> <input type="checkbox"/> <input type="checkbox"/>	350mm 30mm Standard	13/Count 13/Count 4/1 4/2 4/3 4/4
A10	CLOSING SPRINT MODE SELECT: <i>Standard speed</i> <i>Standard speed + 30%</i> <i>Standard speed + 60%</i> <i>Standard speed + 90%</i>	<input type="checkbox"/> <input type="checkbox"/> <input type="checkbox"/> <input type="checkbox"/>	Standard	4/1 4/2 4/3 4/4

Continue on overleaf

# General Commissioning Check Sheet

Fill in data for later reference

Model:		Actual	Default	L.E.D. Quick Ref.
A10	MOTOR CUTOFF TIME		60 Secs	15/Time
A10	INVERTED RACK	Rack below pinion <input type="checkbox"/> Rack above pinion <input type="checkbox"/>	Above	16/1 16/2



## CE Compliance

The following checks must be made in addition to the above checks to ensure a CE compliant installation:

P36 PASSIVE EDGES FITTED TO ALL HAZARDOUS EDGES	<b>YES</b>
D3 OPERATOR INSTALLED, WITH CE CHIP FITTED TO CONTROLLER	<b>YES</b>
COLLISION SENSITIVITY (see above) SET TO HIGH OR MEDIUM	<b>YES</b>

# Notes

---



# CENTURION

THE AUTOMATIC CHOICE



---

CENTURION SYSTEMS (PTY) LTD HEAD OFFICE:  
TEL: +27 (0)11 699-2400, FAX: +27 (0)11 704-3412 or 462-6669  
148 EPSOM AVENUE, NORTH RIDING  
P.O. BOX 506, CRAMERVUE, 2060  
SOUTH AFRICA

WEB: <http://www.centsys.co.za> General information e-mail: [info@centsys.co.za](mailto:info@centsys.co.za)

---

## FOR TECHNICAL SUPPORT CONTACT:

### SOUTH AFRICA

EAST RAND . . . . .	(011) 397-6401	PORT ELIZABETH . . . . .	(041) 581-6994
DURBAN . . . . .	(031) 701-9583	EAST LONDON . . . . .	(043) 743-4923
NELSPRUIT . . . . .	(013) 752-8074/5	BLOEMFONTEIN . . . . .	(051) 448-1714
PRETORIA . . . . .	(012) 362-8819/8893	KIMBERLEY . . . . .	(053) 832-3231
CAPE TOWN . . . . .	(021) 447-1295	VEREENIGING . . . . .	(016) 422-5667

### AFRICA

ECHO-LINE, NAMIBIA . . . . .	Tel: (61) 220-8309
MOLECULAR CONSULTANTS, NIGERIA . . . . .	Tel: 803-3123182
SECURITY DISTRIBUTORS, ZIMBABWE . . . . .	Tel: (4) 795-873
SEKANYOLYA TIMBER WORKS, UGANDA . . . . .	Tel: (41) 231-40

### EUROPE

AUTOMATISME BATIMENT, FRANCE . . . . .	Tel: (1) 697-93120
NESTOR, BELGIUM . . . . .	Tel: (9) 380-4020

### NORTH AMERICA

BILLY GATES, CANADA . . . . .	Tel: (250) 334-1553
-------------------------------	---------------------

### AUSTRALASIA

ABA GATES, WESTERN AUSTRALIA . . . . .	Tel: (8) 933-03061
ROTECH, QUEENSLAND, AUSTRALIA . . . . .	Tel: (7) 326-47330
SA GATES, SOUTHERN AUSTRALIA . . . . .	Tel: (8) 826-64235
TOLPARK SYSTEMS, NEW SOUTH WALES, AUSTRALIA . . . . .	Tel: (02) 4677-1004
ICBT, VICTORIA, AUSTRALIA . . . . .	Tel: (3) 933-54213
DOMINATOR SYSTEMS, NEW ZEALAND . . . . .	Tel: (3) 384-5145
SECURITE DU PACIFIQUE, NEW CALEDONIA . . . . .	Tel: 283-760

### INDIAN OCEAN

SECULOGIX LTD, MAURITIUS . . . . .	Tel: 467-8509
SECURITE AUTOMATISMES REUNION, REUNION . . . . .	Tel: 280-368

### ASIA & PACIFIC

VAST VIDEO, MALAYSIA . . . . .	Tel: (3) 214-34931
BLT ASSOCIATES, THAILAND . . . . .	Tel: (2) 691-6793