

## Description

Components required for 1 to multi apartment kits

Entry Panel  
(Made up in 2 button increments to suit number of call buttons required)

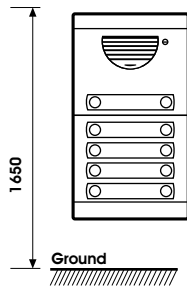

Surface Box  
mild steel or  
3CR12 stainless steel  
with light grey epoxy coating  
(Select size according to  
configuration of entry panel)

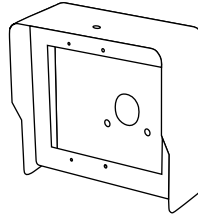

Power supply unit  
CP13E/12V

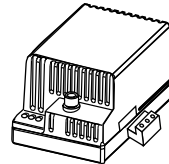

alternatively connect to  
12V DC battery of gate motor

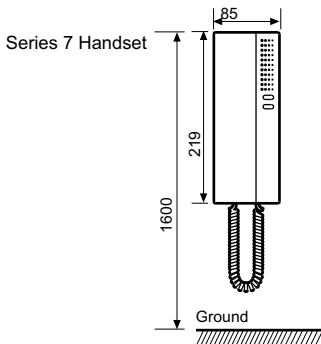
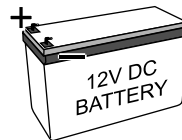

## System operation

When a call button on the outside entry panel is pressed all the handsets connected to this call button will ring. A maximum of four handsets can be connected to one call button. There will be a simultaneous ring at the entry panel to confirm the ringing at the handset(s). When lifting the handset off its cradle inside, communication between the handset and entry panel can take place. If at the same time any other handset is lifted off its cradle, there will be common communication with the first handset and the entry panel. At any time any handset in the system can be lifted off its cradle and there will be a communication link with the entry panel. This is regardless of whether this handset has been called from the entry panel. The speech volume at the handset(s) and entry panel can be set independently. The entrance door or gate can be operated using the door/gate release pushbutton provided on the handset. A second pushbutton is provided to operate auxiliary functions such as other features on the entrance gate operator or switch a light outside the front door or gate. A pushbutton is provided on the entry panel to illuminate the call button label and improve usability in dark conditions. This latest generation of entry panels, the Series 7, simplifies the installation of the system, and through improved weatherproofing enhances the long term reliability of the product.

## Line diagram for Series 7 entry panel

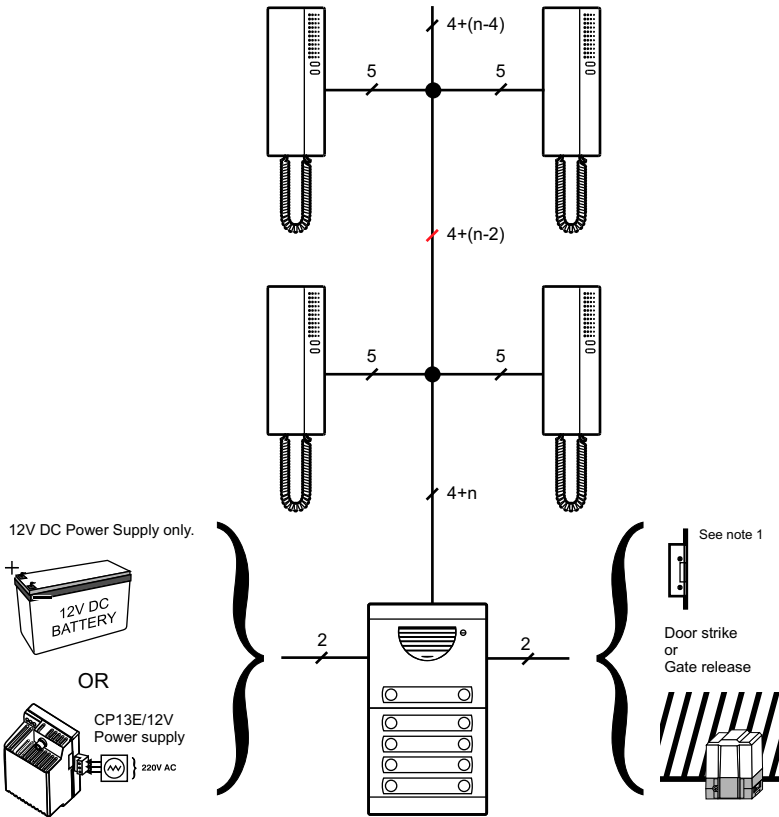

### Table of recommended cross-sections

Connections	Door strike or Gate release	Power Supply	Entry Panel	Call Button	Number of wires	Min. Cross-sections (mm <sup>2</sup> )		
						50 m	100 m	200 m
9, 10					2	1.5	2.5	
3, 4, 5					3	0.25	0.25	0.5
1E, 2					$1+n^{\dagger}$	0.25	0.5	$2^2$
10, 11					2	1.5	2.5	
2, 3	ALTERNATIVELY				2	0.25	0.25	0.5

### NOTES

1 - A door strike can only be connected directly to the entry panel as shown, if an AC supply is powering the unit.

2 - If the cable distance is greater than 100m a ring amplifier (CP112) is recommended on the call line circuit

<sup>†</sup>n = number of call buttons

# Wiring diagram for Series 7 entry panel

## SITUATION:

1. The gate / door release is used to operate a gate motor and the power supply to the system is either 12V DC or AC.
2. The gate / door release is used to operate a low current door strike and the power supply to the system is strictly 12V AC.

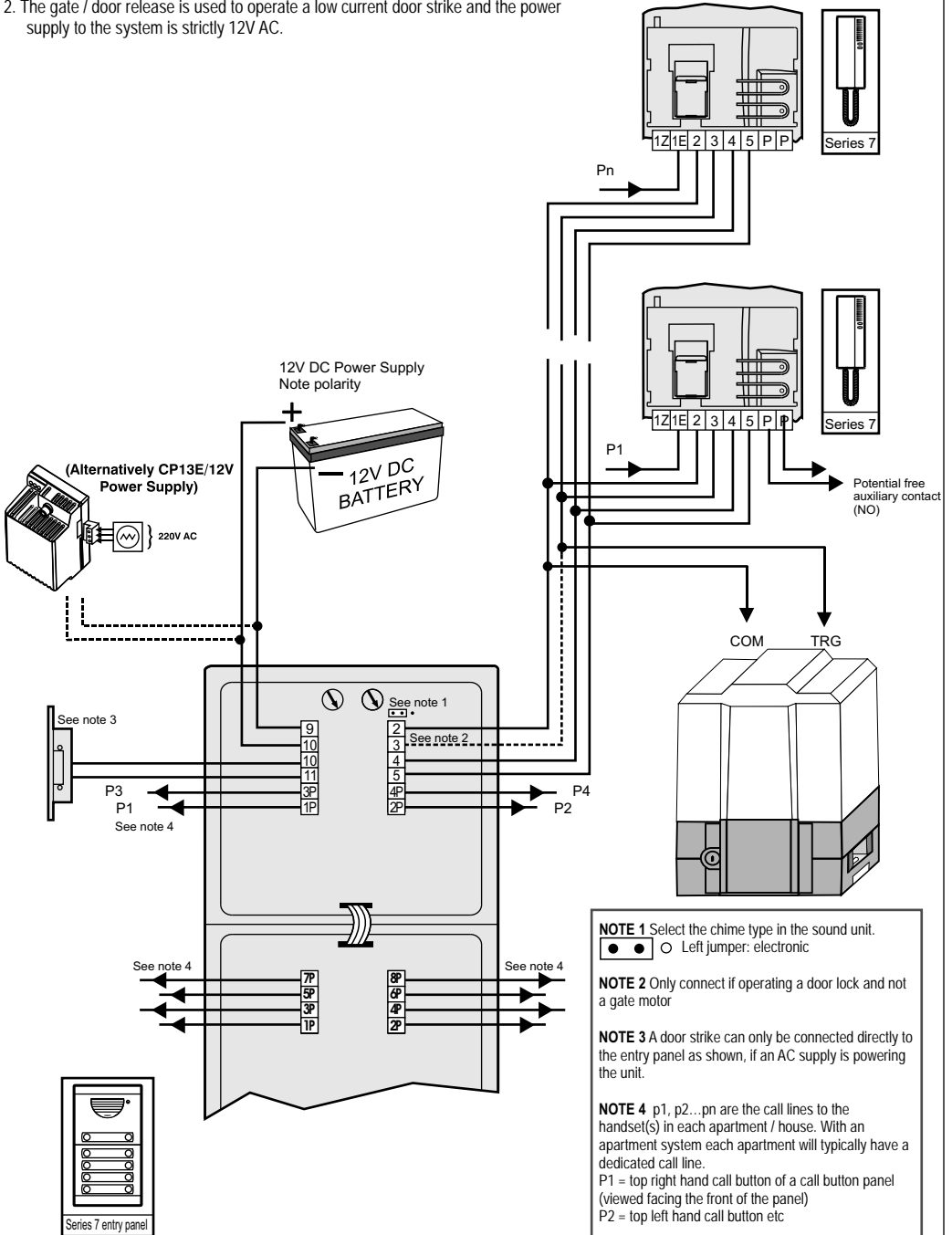

# Wiring diagram for Series 7 entry panel

## SITUATION:

1. Wiring diagram for Series 7 where the gate/door release operates an electric door strike, rim lock or magnetic lock and the power supply is 12V DC.

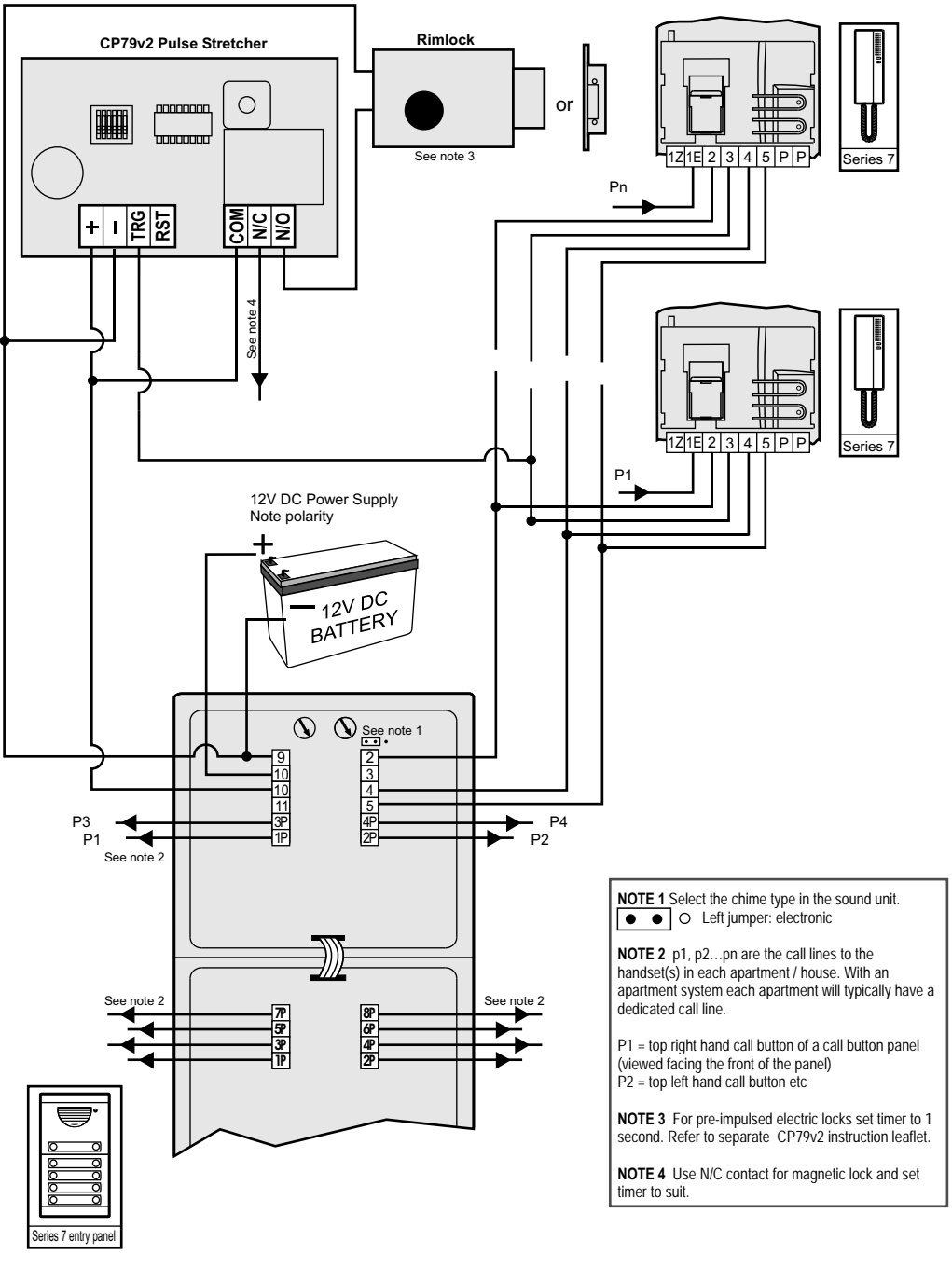

## Extensions

Up to four handsets for the same call.

For two, three or four handsets, multiply the cross-sections by two, three or four (1E,2,9,10).

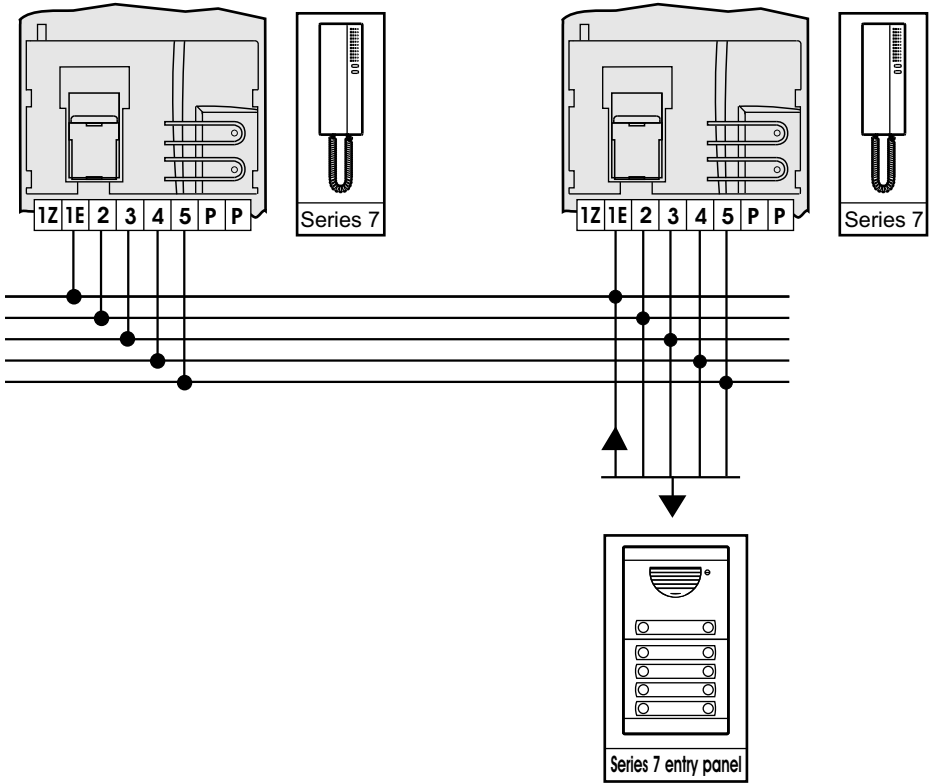

## Accessory

Connection of an electric rim lock to entry panel using an AC power supply only.

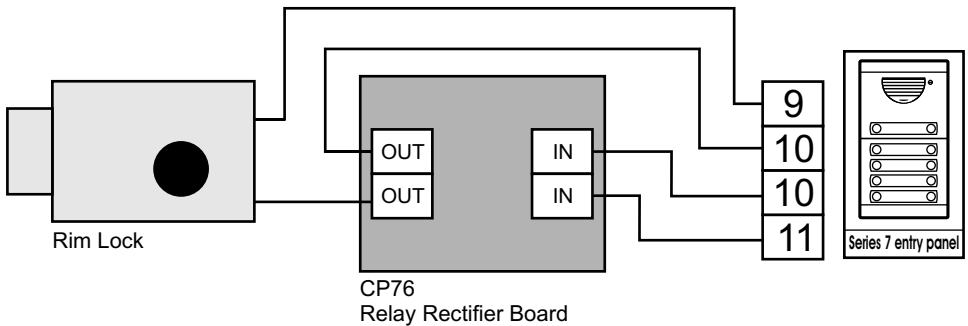

\* Do not connect door strike / rim lock to entry panel as shown if a DC supply is powering the unit.

# Installation

## POSITION ENTRY PANEL

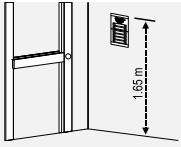

1. Position entry panel on wall adjacent door or entrance gate. Mount at a height convenient for the user to operate. A recommended height is provided.

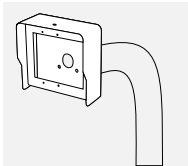

2. Alternatively mount the entry panel onto a gooseneck ensuring that - The entry panel does not protrude too far into the driveway - The entry panel is not set too far back and cannot be easily operated.

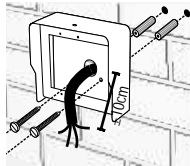

3. Mount surface box into position against wall or onto gooseneck. Route cables into the surface box ensuring that there is sufficient length (>10cm) to allow easy termination onto the entry panel

## FIT CALL BUTTON ADDRESS LABELS



4. To fit the call button address labels it is necessary to remove the different modules with call buttons, from the entry panel support frame.

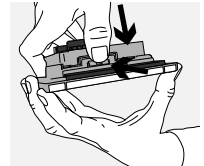

5. Grip the outside of the frame as shown and depress the securing clips on one side of the module and push the module away from the frame

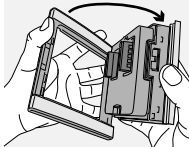

6. Rotate the frame and repeat the procedure to unclip the opposite side. release the module fully from the frame

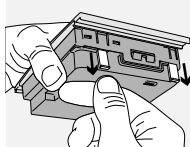

7. Orientating the module as shown, pull the white locking tabs downwards

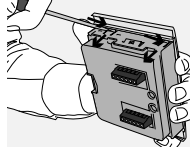

8. Hold the module as shown and depress one by one the securing clips on one side to release the plastic part of the module from the facia.



9. Peel the module away from the facia

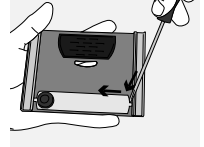

10. Using a screwdriver with a small flat, carefully unclip the plastic call button backing piece from the facia. Insert the label and replace the plastic backing piece

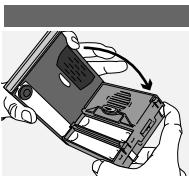

11. Clip the module back onto the facia

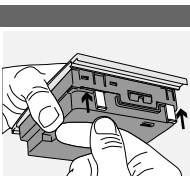

12. Slide the white locking tabs back into position as shown

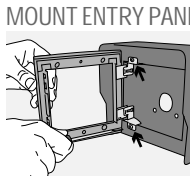

13. Using the small set of self tapping screws provided, secure the hinges of the entry panel support frame onto the surface box

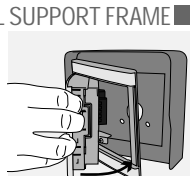

14. Slide the call button / audio module(s) back into position in the support frame, ensuring that there is positive engagement

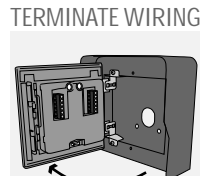

15. Hinge open the entry panel and terminate the wiring referring to the wiring diagram overleaf

## CLOSE UP ENTRY PANEL

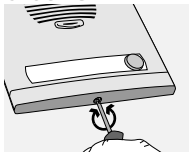

16. Loosen the frame end caps by depressing each locking screw and twisting it either clockwise or anti-clockwise.

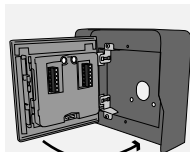

17. Hinge the entry panel closed ensuring that the cabling is folded neatly behind the panel without folding or pinching it between the back of the unit and surface box.



18. Using the larger set of self tapping screws provided, secure the entry panel to the surface box

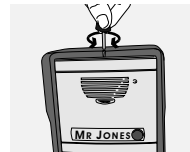

19. Close the frame end caps

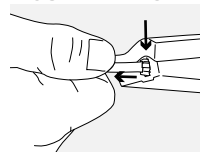

20. Remove the handset from the handset by unplugging the telephone cord.

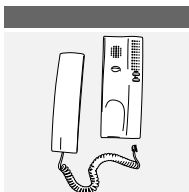

21. Set this aside in order that it does not get damaged during mounting

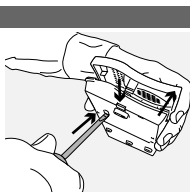

22. Open the handset

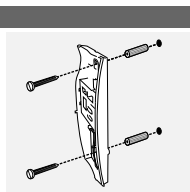

23. Screw the handset against the wall at the recommended height. Terminate wiring referring to the wiring diagram overleaf / attached

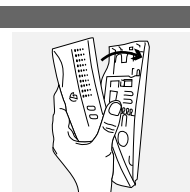

24. Close the handset

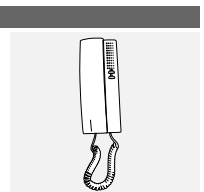

25. Replace handset remembering to reconnect telephone cord.

## Checking

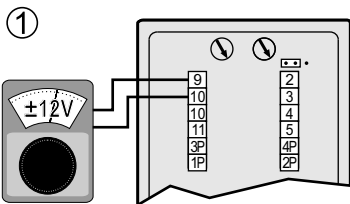

Check Voltage at entry panel

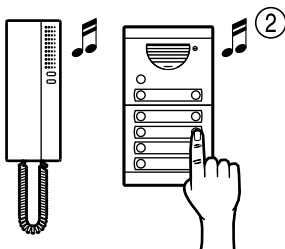

The call sounds in the street panel and the handset

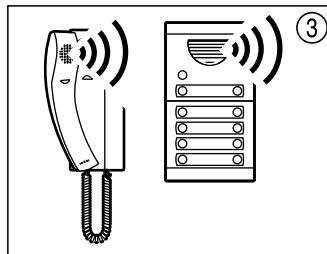

The volume in the street panel and the handset is correct

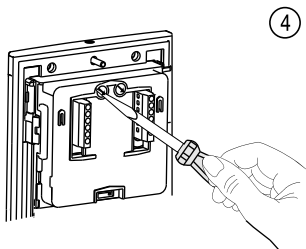

Adjust the volume in the street panel and in the handset.

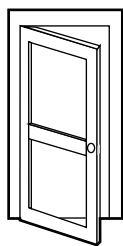

Check the door opening

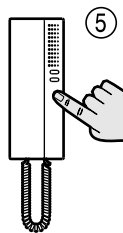

Check the illumination of the label-holder

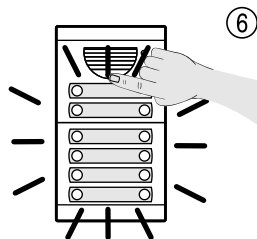

### 1. Nothing works.

Check that there is voltage at the entry panel. Measure +/- 12V AC / DC across terminals 9,10. Check that power is being supplied by either the power supply (check mains supply and mains protection fuses) or the 12V DC of the gate motor battery (check auxiliary supply fuses on the motor consult motor manufacturer). Disconnect power to the system and check for any short circuits or discontinuities in the cabling between the power supply and the entry panel.

### 2. The illumination of the name-holder does not work.

Check the power input of the entry panel is approx. 12 V AC/DC between terminals 9 and 10. If the voltage is correct, the module is defective.

### 3. Sound feedback (Larsen effect).

Adjust the volume in the entry panel.

### 4. None of the handsets' sound reaches the entry panel.

General installation problem. Check the volume adjustment, the illumination of the light button and the connections between terminals 4 and 2 of the entry panel. If the voltage is correct, the entry panel may be defective.

### 5. One handset's sound does not reach the entry panel.

Handset individual problem. Check the connections between handset terminals 4 and 2. If the voltage is correct, the handset may be defective.

### 6. No sound from the entry panel reaches any handset.

General installation problem. Check the volume adjustment, the illumination of the light button and the connections between terminals 5 and 2 of the entry panel. If the check is satisfactory, the entry panel may be defective.

### 7. No sound from the entry panel reaches one handset.

Handset individual problem. Check the connections between handset terminals 5 and 2. If the voltage is correct, the handset may be defective.

### 8. No handset receives the call from the entry panel.

Check that the lighting button operates correctly. The call setting jumper must be positioned to electronic mode according to the diagram. If the check is satisfactory, the entry panel may be defective.

### 9. One handset does not receive the call from the entry panel.

Check the connection of the pushbutton at terminal 1E of the handset. If the voltage is correct, the handset may be off-hook or defective.

### 10. The latch does not operate from any handset.

The lock must be powered. Check in the entry panel that the voltage is approx. 12 V AC between terminals 9 and 10. If not, refer to point No. 1. Press the electric lock button and check in the entry panel that the voltage is approx. 12 V AC between the terminals 10 and 11. If not, the entry panel may be defective. If the voltages are correct, the problem is caused by the latch.

### 11. Gate release does not operate from one or more than one handset.

Check continuity across terminals 2 and 3 on each defective handset, with cabling to either or both these terminals disconnected. If this test proves negative, the handset may be defective. Check for continuity on the cabling to the gate motor.



**CENTURION**  
**THE AUTOMATIC CHOICE**



---

**CENTURION SYSTEMS (PTY) LTD HEAD OFFICE:**  
TEL: +27 (0)11 699-2400, FAX: +27 (0)11 704-3412 or 462-6669  
148 EPSOM AVENUE, NORTH RIDING  
P.O. BOX 506, CRAMERVIEW, 2060  
SOUTH AFRICA

WEB: <http://www.centsys.co.za> General information e-mail: [info@centsys.co.za](mailto:info@centsys.co.za) Sharecall Number: 0860-CENTURION

---

**FOR TECHNICAL SUPPORT CONTACT:**

JOHANNESBURG CENTRAL/WR. . . . . (011) 699-2400  
JOHANNESBURG EAST-RAND . . . . . (011) 397-6401  
PRETORIA. . . . . (012) 362-8819/8893  
VEREENIGING. . . . . (016) 422-5667  
NELSPRUIT. . . . . (013) 752-8074/5  
DURBAN. . . . . (031) 701-9583  
KIMBERLEY . . . . . (053) 832-3231  
BLOEMFONTEIN . . . . . (051) 448-1714  
CAPE TOWN . . . . . (021) 447-1295  
PORT ELIZABETH . . . . . (041) 581-6994/5  
EAST LONDON . . . . . (043) 743-4923  
GEORGE . . . . . (044) 874-6965  
WINDHOEK . . . . . (09264) 6-1220830  
HARARE . . . . . (092) 634795-873  
GABARONE. . . . . (09267) 351194