



The CENTURION and CENTSYS logos, all product and brand names in this document that are accompanied by the ® symbol are trademarks of Centurion Systems (Pty) Ltd, in South Africa and other territories, all rights are reserved. We invite you to contact us for further details.

EOE Centurion Systems (Pty) Ltd reserves the right to change any product without prior notice

After Hours International Technical Support Call Centre  
+27 11 699 2481 (16:00 to 02:00 - Australian Eastern Time)

Call: 1300 CENTSYS (1300 236 879)

www.centsys.com.au

Call Technical Support: +27 11 699 2481  
from 07h00 to 18h00 (UTC+2)

Head Office: +27 11 699 2400

Call Centurion Systems (Pty) Ltd - South Africa

Subscribe to the newsletter:  
www.centsys.com/subscribe

centurion.systems

@askcenturion

YouTube.com/centurionsystems

facebook.com/centurionsystems

Connect with us on:  
www.centsys.com



GSM-BASED INTERCOM SYSTEM

G-SPEAK ULTRA QUICK GUIDE



G-SPEAK ULTRA



1. What is G-SPEAK ULTRA?

The G-SPEAK ULTRA promotes the ultimate in convenience and peace of mind by combining wireless GSM technology with CENTURION's futuristic and stylish ULTRA interface. Infused with the DNA of innovation, the G-SPEAK ULTRA allows wireless communication between the user and the intercom gate station, effectively turning the user's phone into the intercom handset.

2. Important Safety Instructions

- Do not install this product near DOSS sensor inside gate motor housing or near the remote receiver.
- Do not install this product near any sensitive electrical components.
- All installation, repair, and service work to this product must be done by a suitably-qualified person.
- Do not in any way modify the components of the system.
- Do not install the equipment in an explosive atmosphere: the presence of flammable gas or fumes is a serious danger to safety.
- Do not leave packing materials (plastic, polystyrene, etc.) within reach of children as such materials are potential sources of danger.
- Dispose of all waste products like packing materials, according to local regulations.
- Centurion Systems (Pty) Ltd does not accept any liability caused by improper use of the product, or for use other than that for which the automated system was intended.
- This product was designed and built strictly for the use indicated in this documentation. Any other use, not expressly indicated here, could compromise the service life/operation of the product and/or be a source of danger.
- Anything not expressly specified in these instructions is not permitted.

This icon denotes variations and other aspects that should be considered during installation.

This icon indicates tips and other information that could be useful during the installation.

3. Glossary of Terms

**Filter Time:** Filter Time determines how long an input event (Rising or Falling Edge) must be present before it is recognised, i.e. an SMS or email is sent, or a missed call is initiated. The time is set in increments of one second and the default is 0.

**Blanking Time:** Blanking Time determines how long the unit will wait between events before it will recognise the next event.

**Hang Time:** The time for which the call remains connected after a DTMF event.

**Any Number Mode:** When enabled, this useful feature allows any number to activate the module's outputs, irrespective of whether they are learned into memory. A typical application would be an event such as a wedding where many guests need to be given temporary access. Instead of manually learning in a 100 guests and then having to delete them again after the occasion, the administrator can simply enable Any Number Mode and disable it again afterward.

**DTMF:** Dual Tone Multi-Frequency signaling. This is used for telecommunication signaling over analogue telephone lines in the voice-frequency band between telephone handsets and other communication devices and the switching centre. This allows the user to press a number on his or her mobile handset to switch any of the outputs on the G-SPEAK ULTRA.

**Channel:** An electrical gateway implemented as a physical terminal on the G-SPEAK ULTRA that provides the external interface to Input or Output signals

**Called Party:** When one of the Call Buttons on the Calling Module is pressed, the Called Party is the person or persons who receives/answers the call on their mobile phone or landline handset.

**Calling Module:** This can be seen as similar to a traditional intercom gate station or entry panel that resides outside of the property and is the component of the G-SPEAK ULTRA system that is used to dial through to and communicate with Voice Phones.

**GSM Controller:** A module using 2G GSM (Global System for Mobile Communications) technology to communicate wirelessly with GSM-enabled handsets, allowing both audible communication and monitoring and switching of Inputs and Outputs.

**Voice Phone:** A Voice Phone pertains specifically to the intercom functionality of the G-SPEAK ULTRA system, and is any learned-in phone with the ability to communicate audibly with the Calling Module, but is also capable of activating any of the Outputs during a call using DTMF signaling.

**Switch Phone:** A Switch Phone is a learned-in phone that is capable of exercising some influence upon the Outputs of the controller via GSM switching and does not necessarily possess Voice Phone functionality, though it can be learned in for both.

4. Technical Specifications

Supply Voltage Range	11-24V DC
Maximum Current Draw	300mA @ 12V DC
Input/output Current Rating	50mA (Open Collector)
Input Sense Voltage Range	0-24V DC (0-1.6V Low-input State, 5V-24V High-input State)
SIM Card	Micro-format, Activated SIM Card Supplied (South Africa only) <sup>1,2</sup>
Number of Configurable Input/output Channels	4
Call Buttons on Calling Module	2
Call confirmation at Calling Module	Yes

Speech volume	Adjustable at Calling Module using Call Buttons
Calling Module illumination	Call Buttons and labels with back-lit white LEDs
Memory Capacity	<ul style="list-style-type: none"> <li>5000 Event logs</li> <li>20 Access Profiles</li> <li>1 Custom Welcoming SMS Message for New Access Numbers</li> <li>20 Custom Output Activation SMS Messages (From User to Device)</li> <li>30 Custom Input Notification SMS/Email Messages (From Device to User)</li> <li>100 Visitor Time-barring Windows (Windows are the periods between two dates)</li> <li>30 Generic Time-barring Windows (Windows are weekly recurring)</li> <li>10 Output Activation Schedules (Schedules are weekly recurring)</li> <li>3 Daylight Saving Periods</li> <li>4 Input to Output Mapping Configurations</li> </ul>
Model Options	<p><b>GSM 2G:</b> 850/900/1800/1900MHz (EDGE)</p> <p><b>GSM 3G:</b> 900/2100MHz (EDGE) 900/2100MHz (UMTS)</p> <p><b>GSM 3G PENTA:</b> 800/850/900/1900/2100MHz (UMTS)</p>

TABLE 1

- May not be used in devices other than G-ULTRA (South Africa Only).
- Remains the property of Centurion Systems (Pty) Ltd. (South Africa Only).

5. Product Identification

5.1. G-SPEAK ULTRA

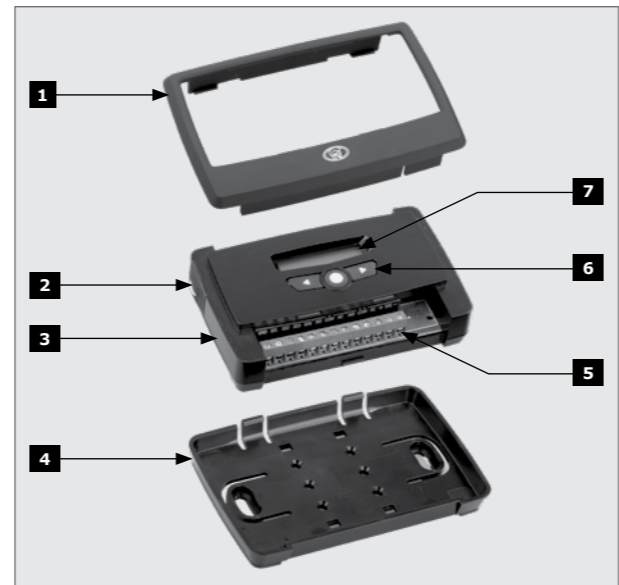

FIGURE 1

- Fascia
- External Antenna Cover
- Main Unit
- Mounting Plate
- Terminal Blocks
- Navigation panel
- LCD Screen

5.2. Calling Module

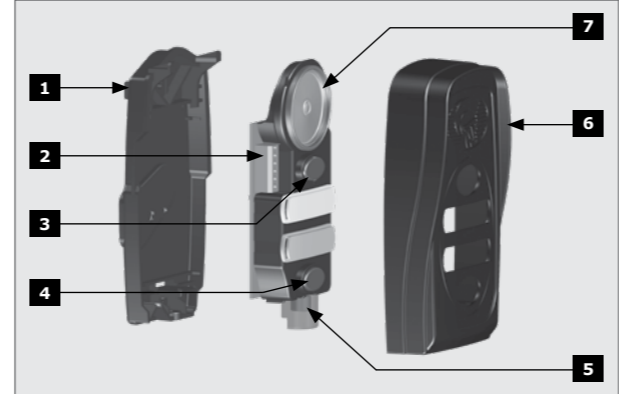

FIGURE 2

- Back Cover / Mounting Panel
- Voice Communication Terminals
- Call Button 1
- Call Button 2
- Microphone
- Front Cover / Fascia
- Speaker

6. Product Dimensions

6.1. G-SPEAK ULTRA



FIGURE 3

6.2. Calling Module

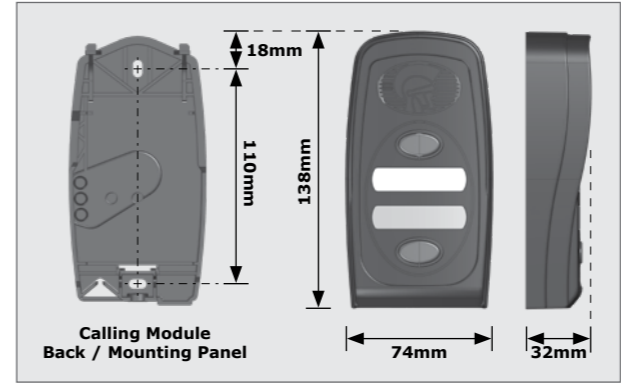

FIGURE 4

7. Functional Feature Highlights

**Access Number Profiles**  
The access number configuration profiles eliminates the hassle of configuring input and output permissions and notifications every time that a new number is added.

**Intelligent Gate Status Monitoring**  
With seamless integration with CENTURION gate motors, the G-SPEAK ULTRA will let the user know when his or her gate has been left open, or is in any other state specified by the user through intelligent monitoring of the gate motor's status output. Adjustable Filter settings mean that the user can specify under which conditions they are notified about a particular gate status, for example if the gate has remained open for longer than 20 seconds.

**Supplied with activated SIM card (South Africa only)**  
All G-SPEAK ULTRA units are supplied with an activated Vodacom SIM card (South Africa only). Airtime can be purchased via G-WEB (South Africa only).

**Monitoring and alerting**  
The device can be configured to monitor up to four separate electrical devices, such as a home alarm or even a water reservoir. It could send the user an SMS, give a missed call or even send an email, letting the user know if the house alarm is on or off or a reservoir is full or empty. When configured as inputs, the unit's four individually-configurable channels can be configured to react to Rising Edges, Falling Edges, or both, which makes it ideal for monitoring variable levels such as mains power. A single input can be used, for example, to send a notification to users when mains power has failed, and the same input can notify users once it comes back on, freeing up the other inputs to take care of monitoring duties for other devices.

**Control**  
When configured as outputs, the device's dry contacts can be used to remotely control electrical devices and appliances such as gate motors, alarms, geysers and lights, to name but a few possible applications. Outputs can be activated via missed call, SMS text message or by pressing a number on the user's phone's touchpad.

**Timed access control**  
(Weekly and Visitor) Set arrival and departure dates and times; guests will only be able to activate the device's outputs between these limits, affording the user maximum security and affording guests maximum convenience. As a special value-add developed specifically with B & B owners in mind, customised arrival and departure messages with welcoming messages, access instructions, etc., can be sent automatically to guests and visitors.

Alternatively, set weekly recurring time-periods (for example 8am to 5pm, Monday to Friday) during which users will have access to the system.

Outside of the configured time-periods, access will be denied.

Add the ability to map inputs to outputs, customise the input and output notification messages and use the G-SPEAK ULTRA in advanced applications and one has a powerful and convenient GSM-based monitoring and control solution. Up to 20 separate text messages with up to five scheduled outputs can be configured.

Time-barring windows can be configured to block notifications, activations or specific access numbers.

**Quick device associations**  
Devices can be associated to a G-WEB profile in a matter of seconds by simply scanning a QR code with one's smartphone and a third-party universal QR scanner application.

**Easy access to diagnostics**  
This smart device provides intelligent feedback via a graphic user interface displaying status, system information and diagnostic messages for the complete ULTRA experience.

**Smart hardware**  
An internal GSM antenna ensures healthier, more reliable network signal strength without the frustration of trying to find the optimal location to mount the unit. If one needs to fit the G-SPEAK ULTRA in a metal enclosure, simply attach an external antenna to the onboard connector.

**Time-barring per call button**  
Each call button can be individually time-barred. For example, the primary button can be time-barred so that only the secondary call button works during the evenings or early in the morning while the primary call button is disabled.

8. Device Layout and Wire Connections

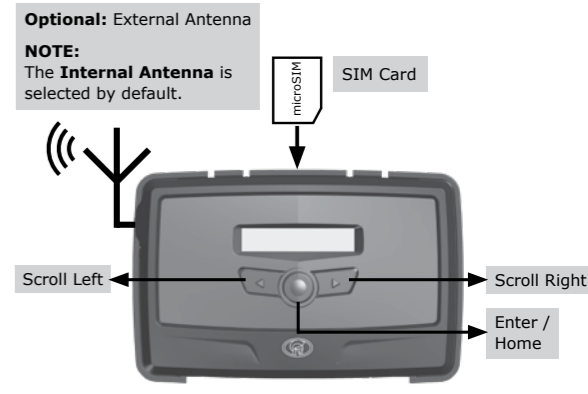

GND	IO1	IO2	IO3	IO4	P1	P2	P3	P4	P5	P6	VIN	NEG
-----	-----	-----	-----	-----	----	----	----	----	----	----	-----	-----

GND	Ground
IO1	Input / Output 1 (Default: Output)
IO2	Input / Output 2 (Default: Output)
IO3	Input / Output 3 (Default: Output)
IO4	Input / Output 4 / Gate Status Input (Default: Output)
P1	Data Communication Line
P2	Data Communication Line
P3	Data Communication Line
P4	Data Communication Line
P5	Data Communication Line
P6	Data Communication Line
VIN	Positive of Power Supply 12-24VDC
NEG	Negative of Power Supply

TABLE 2

9. LCD Interface

Table 3 below lists the information shown on the different screens found on the LCD interface. The left and right scroll buttons are used to toggle between the different screens.

<p><b>Vodacom</b></p>	<p><b>Home Screen</b></p> <p>Network Name or Phone Number Applicable to Incoming / Outgoing SMS or Call.</p> <ul style="list-style-type: none"> <li>Network Signal Strength</li> <li>Connected to Internet</li> <li>Connected to G-WEB</li> <li>Device has Error Condition</li> <li>Incoming SMS</li> <li>Outgoing SMS</li> <li>Incoming Phone Call Events</li> <li>Outgoing Phone Call Events</li> </ul>
<p><b>IO1</b> <b>IO2</b> <b>IO3</b> <b>IO4</b></p>	<p><b>IO Status Screen</b></p> <ul style="list-style-type: none"> <li>Input: Deactivated ("E" = Input event reached)</li> <li>Input: Activated (pulled to ground) ("E" = Input event reached)</li> <li>Output: Off</li> <li>Output: On (pulling to ground)</li> </ul>

	<b>Voltage/Firmware/Date &amp; Time Screen</b> • Supply Voltage • Time • Firmware Version • Date
	<b>Phone Number Screen</b> Device SIM Phone Number.
	<b>Airtime Balance Screen</b> Press Enter to Refresh Airtime Balance from Network Provider.
	<b>GSM Antenna Selected Screen</b> Internal GSM Antenna Selected (default). External GSM Antenna Selected (connect own Antenna to SMA connector). Press Enter to change between Internal and External Antennas.
	<b>Gate Status Screen</b> Gate Closed Gate Opening Gate Open Gate Status Warning
	<b>SIM Screen</b> SIM PIN OK SIM PIN Incorrect SIM Error
	<b>IMEI Screen</b> Displays the device's IMEI number
	<b>Gate station Voice Numbers</b> Displays the primary and secondary Voice Numbers allocated to their respective buttons

TABLE 3

## 10. Configurations

### 10.1. Removing the Mounting Plate and Fascia

To access the terminal blocks of the G-SPEAK ULTRA, the back plate and fascia need to be removed. Follow the instructions below to do this.

#### 10.1.1. Removing the Mounting Plate

Gently pull the two clips at the back backward to release the main G-SPEAK ULTRA unit, and lift the unit out of the mounting plate.

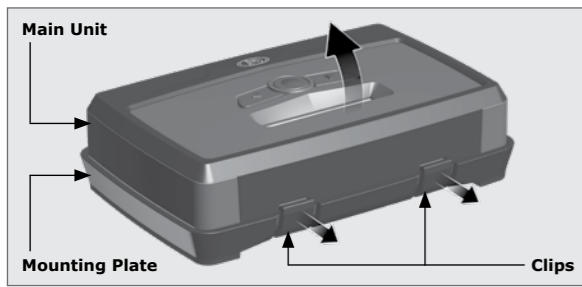

FIGURE 5

#### 10.1.2. Removing the Fascia

The fascia can be removed by inserting the tips of one's fingers into the slots (as shown in Figures 6 and 7), and pulling outward and upward. The fascia should pop off without effort.

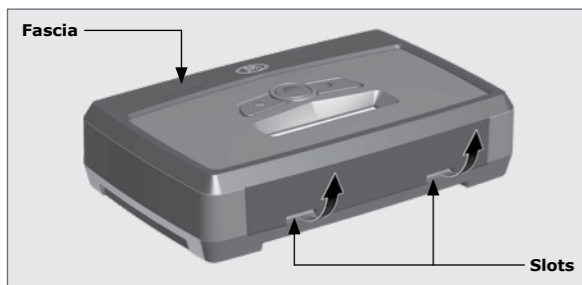

FIGURE 6

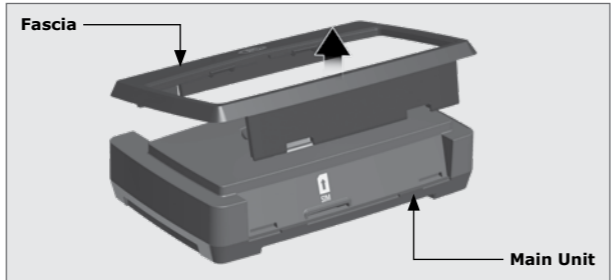

FIGURE 7

Reverse the procedure under Section 10.1 to re-assemble the G-SPEAK ULTRA.

## 10.2. Installation

### 10.2.1. G-SPEAK ULTRA Mounting

#### 10.2.1.1. Wall-mounting

The Mounting Plate is used to mount the G-SPEAK ULTRA device to a wall. Use four screws with wall anchors (not supplied) to secure Mounting Plate.

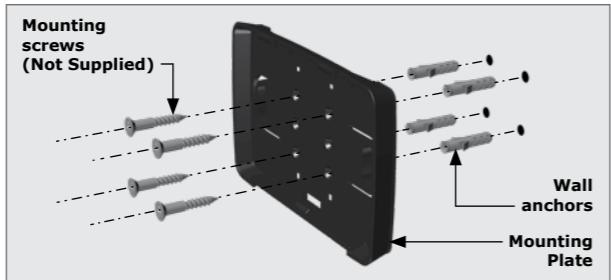

FIGURE 8

Clip the G-SPEAK ULTRA main unit into the mounting plate after it has been secured to the wall; a 'click' will be heard if done correctly.

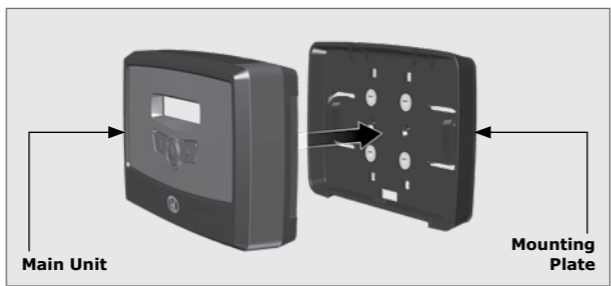

FIGURE 9

#### 10.2.1.2. DIN Rail-mounting

Should the G-SPEAK ULTRA need to be mounted onto a DIN-rail, a DIN-rail mounting kit is available. Enquire at Centurion Systems (Pty) Ltd for more information.

Secure the DIN-rail clips to the back of the mounting plate using four (4) screws.

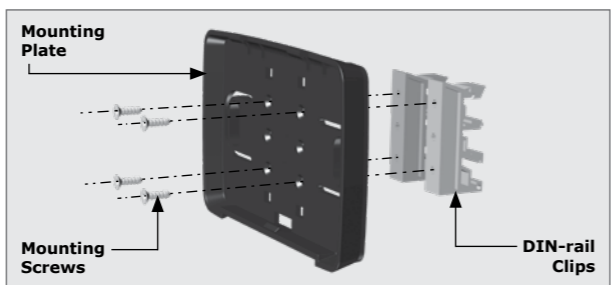

FIGURE 10

Position the bottom of the DIN-rail clips onto the rail, and clip the top end into position(A). A 'click' will be heard if it has been done correctly(B). Clip the G-SPEAK ULTRA main unit into the Mounting plate after it has been secured to the wall; another 'click' will be heard if done correctly.

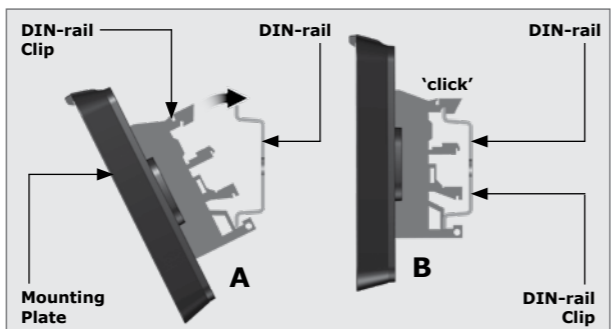

FIGURE 11

To remove the unit from the DIN-rail, remove the main unit from the mounting plate as described in Section 10.1. Insert a small flat screwdriver into the hole(s) shown in Figure 12, and gently pry the clips from the rail.

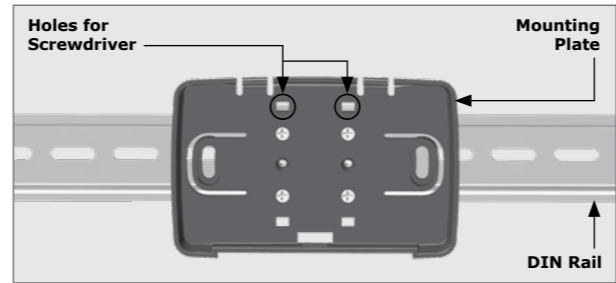

FIGURE 12

### 10.2.2. Calling Module

#### Recommendations for wall mountings

1. Position the Calling Module on wall adjacent to entrance gate or door.
2. Mount at a height that allows for comfortably speaking into the microphone. The recommended height is 1600mm above ground level.

#### Recommendations for Goose-neck mountings

1. Ensure that the Calling Module does not protrude too far into the driveway.
2. The Calling Module must not be set too far back and must be easily accessed from a vehicle.
3. The height should allow for comfortably speaking into the microphone.

#### Gate Station Mounting instructions

Carefully remove the front cover of the gate station. Insert screwdriver as shown, unclip the Calling Module and remove it from the base.

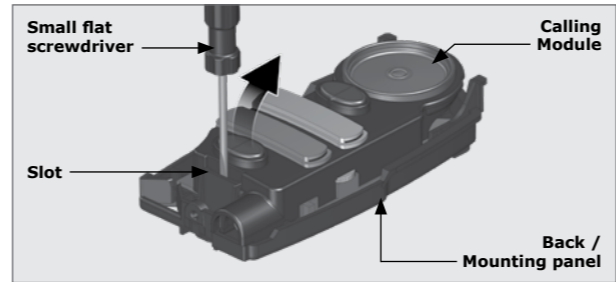

FIGURE 13

The Mounting Panel is used to mount the calling module to a wall or goose-neck. Use two screws with wall anchors (not supplied) to secure the Mounting panel to a wall, or two screw to secure it to a goose-neck.

If the cable is being routed into the unit from a concealed conduit behind the base, knock out one of the cable entry holes provided in the base and feed through the cable. Ensure that at least 100mm of cable extends out of the wall or goose-neck.

Ensure that sealing washer is fitted and closes off the mounting hole to prevent water ingress.

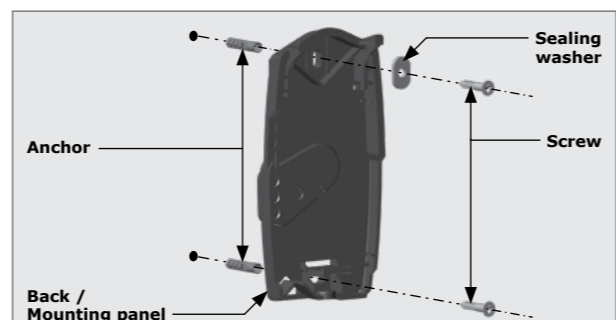

FIGURE 14

Run the cable through the base, hook the Calling Module into the base as shown below and clip the Calling Module back into position.

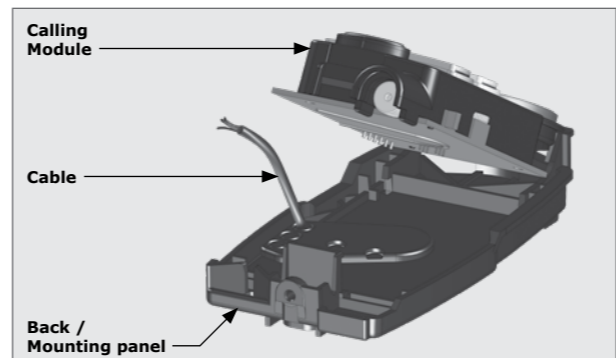

FIGURE 15

If the cable is surface-mounted, route the cable into the unit from underneath.

Terminate the cables into the voice communication terminals by following the wiring diagram found under Section 10.4.

Write Call Button labels, insert into lens(es) and clip lens(es) back onto chassis.

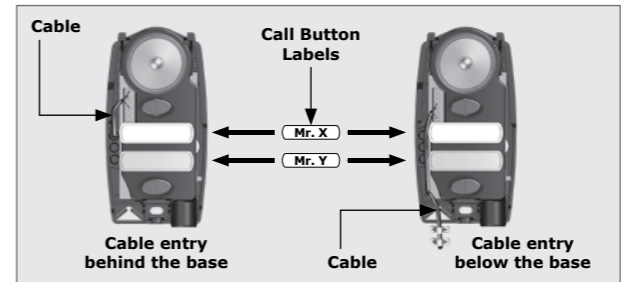

FIGURE 16

Clip the front cover back into position and secure it with the fixing screw provided in the kit.

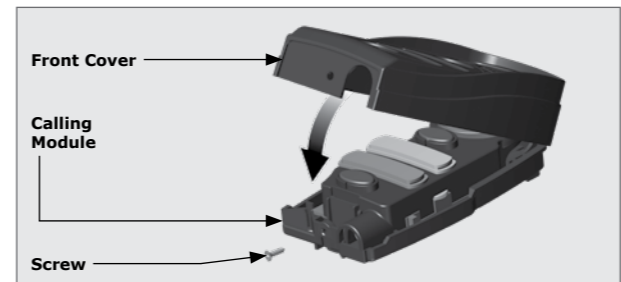

FIGURE 17

## 10.3. Configuration

1. Complete the wiring of the unit as per Section 8 and 10.4 of this document.
2. Power up the device and verify that the device connects to the G-WEB platform by referring to the LCD home screen.
3. Navigate your Internet browser to <http://www.gweb.co.za> (or [www.g-web.com.au](http://www.g-web.com.au) for Australia and New Zealand) and login to your existing profile or, alternatively, register a new profile.
4. On the My Devices page, select Add New G-SPEAK ULTRA Device and follow the onscreen instructions to associate the device to your profile.
5. Configure the device with the desired settings using your online portal.

### 10.4. Wiring Diagrams (Please refer to the online G-ULTRA wiring diagram document for more diagrams)

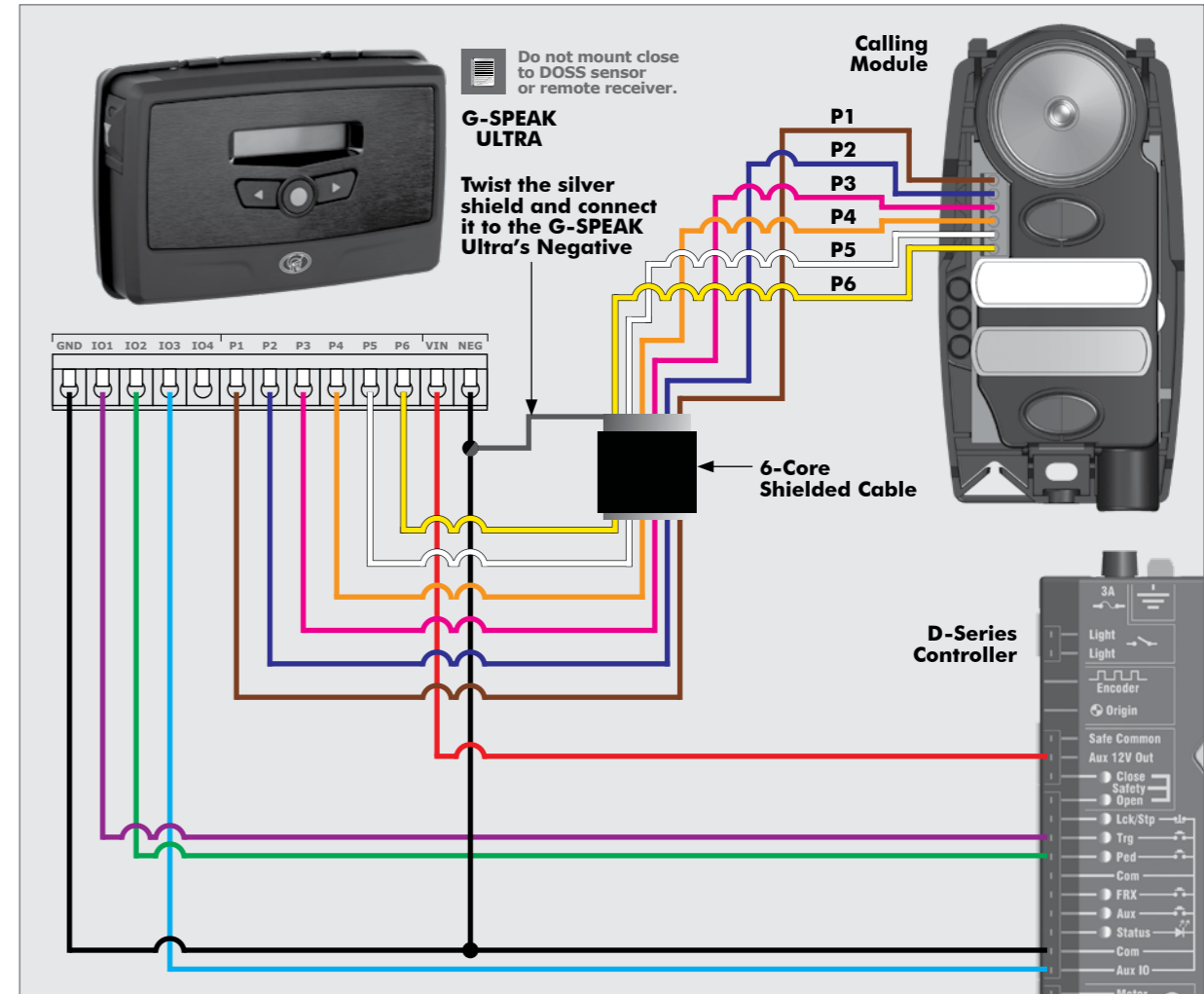

FIGURE 18

**Quick Add:**  
To instantly associate a device to your online profile, scan the QR code using your mobile phone and any universal QR scanner mobile application.

### 10.3.1. G-WEB

All features – both basic and advanced – can be easily, and remotely, configured via the G-WEB online interface. By simply logging into G-WEB using any Internet-enabled device, one can add and delete devices, specify text for input and output notifications and activations, modify device characteristics and a plethora of other features, all from the comfort of one's home or office. G-WEB can be accessed by navigating to <http://www.gweb.co.za> (or [www.g-web.com.au](http://www.g-web.com.au) for Australia and New Zealand). Note that it will be necessary to register if you have not previously done so.

### 10.3.2. SMS Commands

The table below lists the optional basic SMS commands available on the G-SPEAK ULTRA. All basic and advanced configurations can be done via the G-WEB online portal.

SMS Command	Description
P.XXXX!.STATUS	<b>Device Status Request</b> to which the device will respond with the following information: • IMEI • I/O Status • Supply Voltage • Firmware Version • Signal Strength • Relay Status • Device date & time
P.XXXX.AB.27821234567.BU1	<b>Add New Phone Number</b> Adds a new phone number to Profile 0 and to Button1.
P.XXXX.AB.27831234567.BU1.2	<b>Add Secondary Phone Number</b> Adds a second phone number to Profile 0 and to Button1.
P.XXXX.DB.BU1	<b>Delete a specific access number</b> Delete and clear all Voice Phones assigned to Button 1.
P.XXXX.IO	<b>IO Status Request</b> This includes custom IO and state names configured on G-WEB

1. XXXX = Device Default Password

TABLE 4