

NOVA HELIX MULTICHANNEL RECEIVER INSTALLATION GUIDE



NovaHelix
receiver

Centurion Systems (Pty) Ltd
www.centsys.com



www.centsys.com

Connect with us on:

Facebook: facebook.com/centurionsystems

YouTube: YouTube.com/centurionsystems

Twitter: @askcenturion

Instagram: centurion.systems

Subscribe to the newsletter: www.centsys.com/subscribe

Call Centurion Systems (Pty) Ltd * South Africa
Head Office: +27 11 699 2400

Call Technical Support: +27 11 699 2481
from 07h00 to 18h00 (UTC+2)

www.centsys.com.au

Call: 1300 CENTSYS (1300 236 879)

After Hours International Technical Support Call Centre
+27 11 699 2481 (16:00 to 02:00 - Australian Eastern Time)

E&OE Centurion Systems (Pty) Ltd reserves the right to change any product without prior notice

All product and brand names in this document that are accompanied by the ® symbol are registered trademarks in South Africa and/or other countries, in favour of Centurion Systems (Pty) Ltd, South Africa.

The CENTURION and CENTSYS logos, all product and brand names in this document that are accompanied by the TM symbol are trademarks of Centurion Systems (Pty) Ltd, in South Africa and other territories; all rights are reserved.

We invite you to contact us for further details.



SAP code: DOC1213D0501
DOC num: 1213.D.05.0002

1. Introduction

NOVA HELIX is a range of single- and multichannel radio receivers incorporating secure code-hopping technology. The **NOVA HELIX** system offers both link and master learning capabilities to provide the user with the ultimate in usability and security and the technology inherent in all **NOVA HELIX** receivers ensures that the functionality goes well beyond the scope of standard receivers, literally putting unsurpassed convenience at the user's fingertips. In addition, the system supports backward compatibility with the NOVA range of transmitters, meaning that there is no need to purchase additional equipment if presently making use of NOVA.

2. Important safety instructions



- All installation, repair, and service work to this product must be done by a suitably qualified person.
- Do not in any way modify the components of the system.
- Do not install this product near sensitive electrical components.
- Do not install the equipment in an explosive atmosphere: the presence of flammable gas or fumes is a serious danger to safety.
- Do not leave packing materials (plastic, polystyrene, etc.) within reach of children as such materials are potential sources of danger.
- Dispose of all waste products like packing materials, according to local regulations.
- Centurion Systems (Pty) Ltd does not accept any liability caused by improper use of the product, or for use other than that for which the automated system was intended.
- This product was designed and built strictly for the use indicated in this documentation. Any other use, not expressly indicated here, could compromise the service life/operation of the product and/or be a source of danger.
- Anything not expressly specified in these instructions is not permitted.

Please do not proceed with the installation until you have read and fully understand the safety instructions included in your product packaging. The safety instructions are also available on www.centsys.com, and may also be obtained by contacting Centurion Systems (Pty) Ltd on +27 860 236 887 (SA only).

3. Icons used in this guide

This icon indicates tips and other information that could be useful during the installation.

This icon denotes variations and other aspects that should be considered during installation.

This icon indicates a warning, caution or attention! Please take special note of critical aspects that MUST be adhered to in order to prevent injury.

4. General description

The operation manual describes the operation of the **NOVA HELIX** receivers.

- The **NOVA HELIX** functionality allows for both "Master" learning and "Link" learning. Link Learning is the learning process associated with fitting a link to the J1 jumper on the receiver to place the receiver in Learn Mode (no links required) remotely.
- Multichannel receivers support up to 15 unique output channels (SmartSwitch II devices act as the additional physical outputs).
- All receivers support the ability to disable the function jumpers, J1 and J2 for additional security.
- All receivers support SmartSwitch II interfacing capability.
- All receivers support the new timed Autolearn feature.
- Multichannel receivers support advanced channel mapping functionality during Autolearn.
- Multichannel receivers support sticky latch functionality.
- Multichannel receivers support simultaneous channel activation functionality.
- Multichannel receivers support beep-on-activation functionality.

5. Technical specifications

Technical Data	Multichannel Receiver
Operating frequency	433.92MHz
Supply voltage	11V - 30V DC 15V - 22V AC
Quiescent current @ 12V DC	11mA
Maximum current @ 12V DC	40mA
Operating temperature	-15°C - 50°C
Humidity	0 - 90% (non-condensing)
Sensitivity	-115dB
Self-learning memory	250 buttons
Receiver enclosure	UV stabilised ABS

6. Product identification

Multichannel receiver

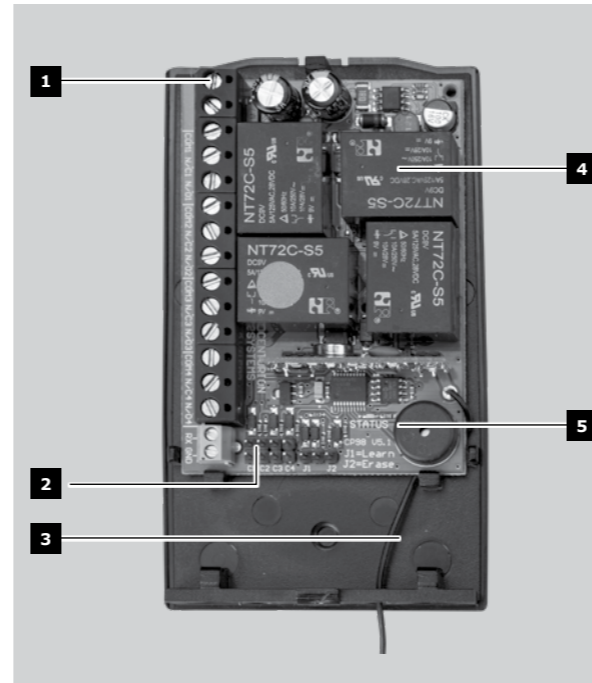

- Terminals
- Jumpers
- Antenna
- Relays
- Buzzer

7. Mounting the receiver

Multi-channel receiver



- Remove the cover from the enclosure using a flat screwdriver.

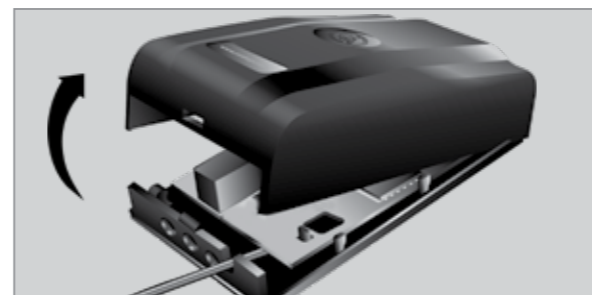

- Remove the cover and unclip the circuit board from the retaining clips

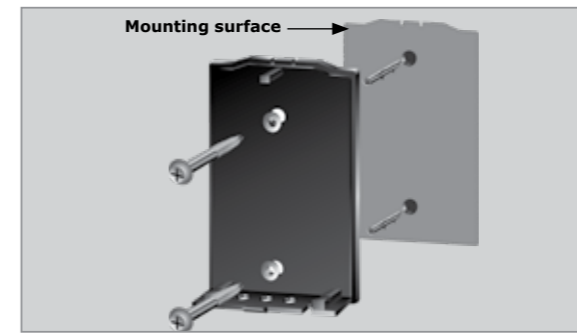

- Mark position of the unit against the mounting surface.
- Using a 5mm masonry bit, drill a hole into mounting surface.
- Mount the unit using suitable fasteners. Mark position of the unit against the mounting surface.

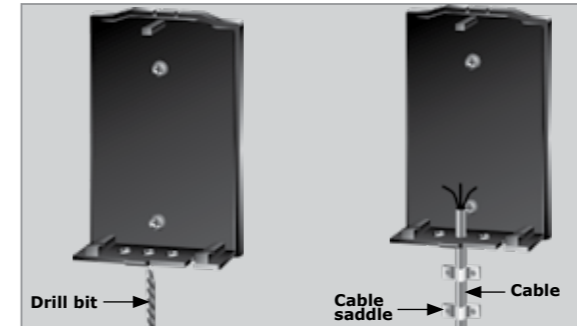

- Use a 6mm drill bit to open the required cable entry hole.
- Re-insert the circuit board and ensure that the retaining clips are holding it in place.
- Fix the cable to the wall using cable saddles.
- Seal all the holes with silicone sealant.

8. Terminal identification

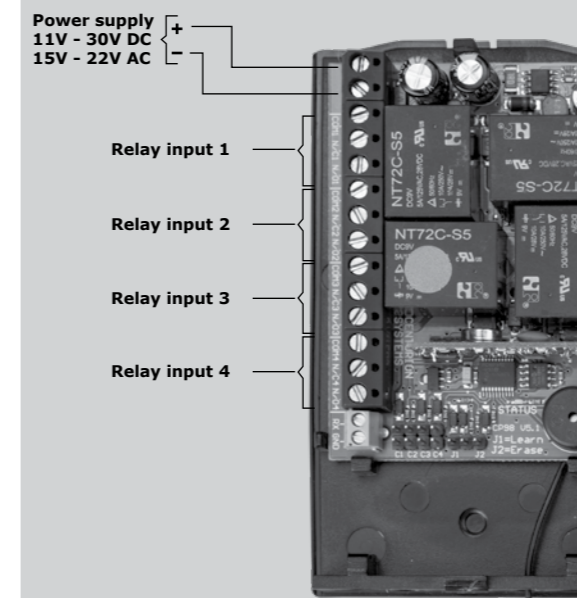

9. Learning the First Master

- To learn the first transmitter button into the receiver, the receiver transmitter memory as well as the channel compartment related to the function being learnt, must be blank. A channel compartment is a memory space that stores all the transmitter buttons that activate the functionality associated with the channel (for example activating a gate motor).

- In the case of multichannel receivers, if a channel other than the first channel (default channel) is to be mastered, start by placing links on the required channel jumpers to select the functionality of interest. This informs the receiver that a channel other than channel 1 is to be mastered.

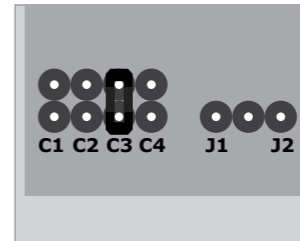

- Press and hold a new transmitter button until a double beep is heard, which will indicate that the button has been successfully learned as a master button. The channel functionality will also activate. This button is said to master the channel that has been selected for learning.
- The button can be released once the double beep has been heard (approximately 5 seconds after the button has been pressed).

10. Learning Additional Master Buttons

- Press and hold the button that presently activates the device in question, for between 10 and 20 seconds. For example, if you want to add another transmitter to your garage door motor, press and hold the button that presently activates it. After 10 seconds, the receiver will provide a long beep to indicate that it has entered the Learn Mode window. The receiver will stay in Learn Mode, for a particular channel, for a period of 10 seconds, failing any additional button presses. While in Learn Mode the LED on the receiver will remain on.
- Any additional remotes learned into the receiver using this method will automatically be granted master privileges. To demaster a button, please follow the steps in section 11.
- Press and hold any remote buttons you wish to learn into the receiver, for a minimum of three seconds, after which a double-beep will indicate successful learning.
- Any button that is pressed while the receiver is in Learn Mode will extend Learn Mode by an additional 10 seconds from the time the button is released.
- If no additional buttons are pressed within the 10 seconds learning period, the receiver will automatically exit Learn Mode. The exit is signalled by an extended single beep. The Status LED also switches off and resumes its responsibilities in normal mode.

11. Demastering Buttons

When a HELIX system is commissioned, all buttons learnt into the receiver are granted master privileges for that receiver. From a security perspective, this is not always desirable. To overcome the potential security issue, the system has the ability to 'demaster' remote buttons.

- Press and hold the master button that is associated with the same functionality as the buttons that need to be demastered. The master button must be pressed for between 20 and 30 seconds.
- After a long double-beep indicates that 20 seconds have elapsed, release the button. Ignore the single beep at 10 seconds.
- The receiver will remain in Demastering Mode for a period of 10 seconds failing any additional button presses.
- Press and hold the button you wish to demaster for a minimum of three seconds.
- Any transmitter button which is pressed will be acknowledged with a short beep.
- A short triple-beep acknowledges the demastering operation, but the button is only demastered once it is released.
- If no additional buttons are pressed within the 10 seconds Demastering Period, the receiver will automatically exit demaster mode. This exit is signalled by an extended single beep. The Status LED also stops flashing and resumes its responsibilities in normal mode.

To determine whether a button has been demastered, note the behaviour of the Status LED when the button is pressed. A demastered button will turn the LED on while the button is being pressed.

12. Deleting Buttons

To delete transmitter buttons, follow the steps detailed below:

- Follow the steps to enter Demastering Mode. For reference follow steps one through four in the Demastering Buttons section. The Demastering Mode channel need not be the same as the channel associated with the button that must be deleted.
- While in Demastering Mode, press and hold the button that must be deleted for between 10 and 20 seconds.
- After holding down the button for 10 seconds, the receiver will emit a short beep.
- After the short beep the button must be released.
- The receiver indicates a successful deletion operation with four short beeps.
- Once deleted, the system transitions back to Demastering Mode. Further buttons may be deleted following steps 2 through 7. Remember the system must remain in demastering mode to delete buttons.
- If no additional buttons are pressed within the 10 seconds demastering period, the receiver will automatically exit demaster mode. This exit is signalled by an extended single beep. The Status LED also stops flashing and resumes its responsibilities in normal mode.

13. Link Learning

Link Learning is the learning process associated with fitting a plastic link over the J1 pin and the common (middle) pin on the receiver in order to learn remote buttons into memory. Learning buttons using this method will also grant buttons master privileges.

- Fit the link to J1 with power on the receiver. On multichannel receivers, fit the links on the channel jumpers to specify the functionality that is required for remotes that are to be learned into the system.

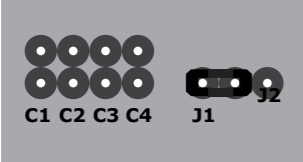

- If no channel jumpers are linked, the system defaults to learning to channel 1.

- When jumper J1 is fitted, the LED will turn on as per Master Learn Mode.
- Press a new button to learn it into the system.
- If the button is a new button, the LED will switch off while the but-ton remains pressed to confirm that the system has detected that a new transmitter button has been pressed. Once the button is released, a short double-beep will confirm that the button has been learned into memory.
- If the button is a demastered button, the LED will flash while the button is held down. Once the button is released, a short single beep will confirm that the button has been successfully remastered.
- Any additional remotes learned into memory are also given master privileges. Hence every button added to the receiver in this way automatically becomes a master for functionality with the channel specified by the channel jumpers.
- There is no timeout associated with Link Learning Mode. The receiver will exit this mode once the link bridging jumper is removed from J1.

14. Link Erase Mode

There are two primary types of erase that pertain to all the receiver variants:

- Transmitter Memory Erase
- Settings Memory Erase

The procedure to perform the erase operation is documented below:.

- Start with the receiver powered up.
- If a particular channel compartment must be erased (in other words, if all the remote buttons associated with a particular channel must be erased), then fit the channel jumpers that select the desired channel.
- If the entire memory must be erased (or the Settings Memory must

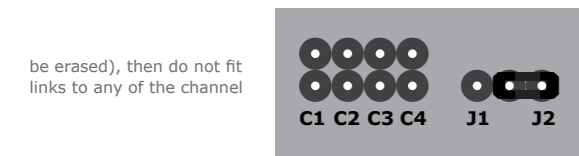

be erased), then do not fit links to any of the channel

- jumpers.
- Fit a link bridging J2 and the common (middle) pin.
- The LED will flash 10 times to indicate that it is about to enter the erase procedure. The link may be removed at this early stage without the erase operation completing.
- After the LED has flashed 10 times, it will turn on. The procedure may still be aborted at this late stage by removing power to the receiver.
- Remove the link across jumper J2 and the middle pin to complete the erase operation.
- The LED will switch off once the relevant memory section is erased. The receiver will return to normal operation after the erase operation completes.

The property that differentiates the two erase operations is the state of the Transmitter Memory. If the memory is not blank (i.e. buttons are learnt into memory), then the receiver will perform the Transmitter Memory Erase operation. If, on the other hand, the Transmitter Memory is blank, then the Settings Memory Erase operation is performed.

15. Remastering Buttons

If a button has been demastered, it can be remastered. There are two methods to achieve this, namely:

Link Learn Remastering

- To remaster a remote, start by entering Link Learn Mode. For reference follow steps 1 and 2 in the Link Learning section
- To remaster buttons associated with a specific channel, fit the channel jumper links for that channel. With links fitted, only buttons associated with a selected channel can be remastered. All other buttons will register on the receiver, but will not be processed.

- To remaster buttons without regard for the channel they are associated with, do not fit any links on the channel jumpers. This will inform the receiver that it must remaster any demastered buttons that are pressed while in this mode.

- With the learn link fitted, press and release a demastered button to remaster it. If a new button (button not learned into the system) is pressed in Link Learn Mode, it will be learned into the system (refer to the previous section, Link Learning for more information).

- The leading edge of the demastered button transaction is acknowledged with a short beep. This beep occurs irrespective of whether the button is mastered or demastered (in fact it will occur irrespective of whether the button is in memory or not).

- While the demastered button is held down, the LED will flash (64 milliseconds on/448milliseconds off) to register that the button transmission is being received, and that the button is a demastered button.

- When the demastered button is released, the receiver will complete the remastering operation and remaster the button. A single short beep will signal the end of the operation, confirming to the user that the button has been remastered. The LED will turn on again at the end of the operation.

- When jumper J1 is removed the receiver will exit Link Learn Mode.

Master Learn Remastering

- To remaster a remote in this mode, start by entering Master Learn Mode.

- Only buttons that are associated with the channel of the master button that entered Master Learn Mode can be remastered in this mode.

- Press and hold a demastered button for a minimum of 3 seconds to remaster it. If a new button (button not learned into the system) is pressed in Master Learn Mode for more than three seconds, it will be learned into the system (refer to the section, Learning Additional Transmitters for more information).

- This beep occurs irrespective of whether the button is mastered or demastered.

- While the demastered button is held down within the demastering window (minimum 3 seconds), the LED will flash (64 milliseconds on/448 milliseconds off) to register that the button transmission is being received, and that the button is a demastered button24.

- Once the demastering period has elapsed (minimum 3 seconds), the LED will turn on and the buzzer will provide a single short beep. This serves as visual and audible confirmation that the receiver has learnt the button being pressed. The LED will turn on again at the end of the operation.

- Once remastered, the system transitions back to Master Learn Mode. Further buttons may be remastered by following steps 3 through 6.

- If no additional buttons are pressed within the 10 seconds Master Learn Mode period, the receiver will automatically exit learn mode. This exit is signalled by an extended single beep. The Status LED will turn off and resume its responsibilities in normal mode. This beep occurs irrespective of whether the button is mastered or demastered.

16. Advanced Features

Bulk Demastering

Since all remotes that are added to a receiver are always added with master privileges, the HELIX offers users a facility whereby certain groups of remotes, currently learnt into the receiver, can be demastered simultaneously. This is an important feature since having multiple masters might at times be considered a security risk.

To bulk demaster remotes, follow the procedure highlighted below:

- Ensure that there is no power on the receiver.

- If the receiver is a multi-channel receiver, place links on the channel jumpers to select the channel that will be bulk demastered. All the buttons associated with this channel will be demastered. If all buttons (i.e. buttons associated with any channel) must be demastered, leave the channel jumpers unlinked.

- Fit the link across J1 and the middle pin and power up the receiver. If the channel compartment pertaining to the selected channel is not blank (has a least one button, whether it is mastered or not, associated with the channel), then the receiver will enter Bulk Demaster Mode. If the entire memory is selected for demastering, then at least one button must be learnt into memory (on any channel) to enter Bulk Demaster Mode.

- After the firmware version number has flashed on the Status LED, the LED will begin to flash quickly to signal that the receiver has entered Bulk Demaster Mode. If the LED does not flash quickly then the

system is not in Bulk Demaster Mode. Either because jumper J1 was not linked correctly before power-up, or because there are no buttons learnt into memory (or associated with the channel selected by the channel jumpers).

- To confirm the bulk demastering operation, jumper J1 must be removed. If the receiver is powered down before the jumper is removed, the bulk demastering operation is not executed. This is useful if the mode is entered accidentally and no buttons must actually be demastered.

Autolearn Mode

Autolearn functionality allows the receiver to remain in Learn Mode for a maximum period of 7 days, after which it will automatically time-out. This is useful in cases where not all individuals who have been issued with remotes are present in order to learn their remotes into the receiver’s memory. Multichannel receivers now support the ability to map buttons to channels during the Autolearn process. Power down the receiver prior to commencing the procedure for entering Autolearn Mode.

- Channel compartments configured for Autolearn must be blank. In other words, the entire Transmitter Memory need not be blank to enter Autolearn, only the relevant compartments. As a result, it is possible to enter Autolearn Mode multiple times; so long as the channels configured for the Autolearn session are blank.

- Fit the desired channel links for the channel that is intended for auto-learning. It is possible to omit channel links and enter Autolearn for channel 1, but only if the channel is blank.

- Fit the link across J1 and power up the receiver. One of two possible situations will result:

- The selected channel (set via the channel jumpers) is blank. In this case the system enters the Autolearn Commissioning procedure. The receiver remains in this state while the link on J1 remains fitted. While in the commissioning state, the LED on the receiver remains on. Entry to the commissioning state is also signalled by a long beep from the buzzer. Continue to step 4.

- The selected channel (set via the channel jumpers) is not blank, or no channel has been selected (no channel links fitted). In this case the system enters Bulk Demaster Mode. Refer to the section with the title, Bulk Demastering, for more information on the behaviour of the system in this mode.

- Press a button on a transmitter to establish the button-to-functionality (channel) relationship. The transmitter that is used to establish the relationship is not learned into memory at this initial stage (although a button that is already learnt into memory may be used). It is purely used to establish the relationship between a button and the selected channel. The LED will turn off while a button is pressed. The LED will turn on again and the buzzer will sound briefly when the button is released. This confirms that the button has been successfully received and added to the association table.

- The last button that is pressed for a given channel will dictate the button-to-functionality relationship. For example, suppose button 1 is initially pressed and associated with a channel; channel 3 for argument’s sake. If button 2 is pressed subsequently, and it is the last button to be pressed during the channel 3 association process, then button 2 will ultimately be the button associated with channel 3.

- To add another channel to the current Autolearn operation, change the channel links to the new channel of interest. Remember, only channels that are blank can be placed in Autolearn mode. If a channel that is not blank is selected via the channel jumpers, the LED will turn off on button press, but the receiver will not generate a beep when the button is released. This will signal that the channel is not blank and therefore that Autolearn may not be enabled for that channel.

- Repeat steps 4 through 6 to establish button-to-functionality relationships for all the (blank) channels of interest.

- Once the association table has been finalised, remove jumper J1. This confirms the mapping and enters Autolearn mode. The buzzer will beep four times to confirm the transition to Autolearn mode. While in Autolearn mode, the LED will remain on while the system is idle. When the correct transmitter button (only buttons registered in the association table are accepted) is pressed, the LED will turn off. When the button is released, the LED will turn

17. Output Configuration

Channel settings modify the way a receiver output responds when it is activated. The output can be configured to act as a latching output, a panic output or any combination thereof. A latching output provides the required drive logic for alarm or equivalent output functionality. Every button transaction associated with a latching output will toggle the current output state of the channel.

In the case of multichannel receivers, channel settings are set on an output by output basis. To select a particular output, link the relevant output jumpers (channel jumpers). For example: To set output 1, place a link on channel jumper C1 only. To set channel 11 (a SS II device output), place links on channel jumpers C1, C2 and C4 (the binary combination of C1, C2, and C4 that results in 11 - b’1011’).

Proceed as per the steps below to set the required output configuration for the specified output.

- Power down the receiver, and link the relevant channel jumpers to configure the respective receiver outputs. On multichannel variants, if no channel is specified via the channel jumpers, the system will not enter channel configuration mode.

- Link jumper J2, and power-up the receiver.

- After the firmware version number has flashed on the Status LED, the buzzer will provide three short beeps to acknowledge the fact that the receiver is powering up in channel configuration mode.

- Press and hold any master button that is learnt into the system for approximately 3 seconds. The receiver will transition into Channel Configuration Mode. The receiver will proceed to flash in the manner indicated in Table 10 - One short flash and then a 1 second delay. Then two short flashes and a 1 second delay. Then three short flashes and a 1 second delay. Finally four short flashes and a 1 second delay. While jumper J2 remains bridged the flashing process repeats itself indefinitely.

- The link on J2 must be removed once the number of flashes on the receiver matches the number of flashes that will set the required output configuration - refer to the table below.

- Once the output configuration has been set, it is possible to proceed to set the output pulse time. This step may be skipped by either waiting 5 seconds for the receiver to time out, or by removing power from the board. In either of the two cases, the currently set output pulse time will be maintained.

- To adjust the relay output pulse time, fit the link across jumper J2 again. Ensure that this is done before the 5 second timeout period elapses.

LED flashes	Latching	Panic
*	OFF	OFF
**	ON	OFF
***	OFF	ON
****	ON	ON

18. Non-Volatile Latches (Sticky Latches)

This is a special feature on all receiver variants that allows the receiver to restore its output state on power loss. When power is restored, the output will assume the state it last reflected prior to the receiver losing power. Normally a receiver that has latched channels will always power-up with the channels unlatched; regardless of the output state of the channel prior to power loss. The sticky latch feature addresses this problem (in applications where it is seen as a problem), and restores the output state of the latch to its state prior to power-loss.

19. Output Configuration

It is possible to disable the functionality associated with jumpers J1 and J2. Receivers are often placed in elevated environments to optimise the range of the receiver. Often, little or no attention is paid to securing the receiver. If the receiver unit is not secured it is possible for a perpetrator to access the jumpers on the receiver and learn a remote into the system without the knowledge or consent of the user. the **HELIX** range includes functionality to disable the jumpers. With a master remote, the jumpers may be re-enabled at any stage.

The following procedure documents disabling the jumper interface on the **HELIX** range of receivers.

- At least one master transmitter must be learned into the receiver memory.
- Press and hold a master button for between 20 and 30 seconds. This will cause the receiver to enter demastering mode; a single beep at 10 seconds must be ignored, and the button can be released upon hearing a long double beep after 20 seconds.
- While in this mode, fit the link between J2 and the middle pin. The Status LED will remain on as long as the pins are bridged.
- When jumper J2 is removed, both jumpers will be disabled and no further jumper operations may be performed.

To re-enable the jumper interface, repeat steps 1 through 4 again.

For further information and programming instructions pertaining to the various advanced features found on Helix receivers, please refer to the appropriate sections in the Helix Full Installation Manual, downloadable from our website www.centsys.com.

